



Horseshoe Pitching NEWSLINE

Official Publication of the National Horseshoe Pitchers Association
VOL. 13, NO. 6

NOVEMBER / DECEMBER 2001



MAYOR OF RED DEER WELCOMES DAVE LOUCKS

• 2001 STATE AND PROVINCIAL TOURNAMENT RESULTS •

Now in 11 models!
 All models are
 NHPA sanctioned
 One year warranty
 on all models

**THOROUGHBRED
 PITCHING SHOES**

Made
 In The
 USA 

A shoe for every style!
 Pairs are matched to
 within 1/5 of an ounce
 All models carry
 a dead soft rating

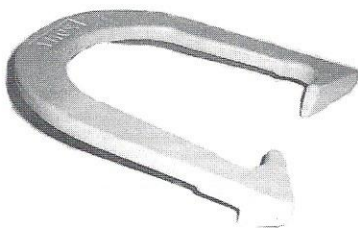

PONY Light-weight shoe
 \$45 PER PAIR

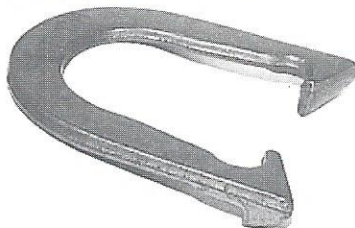

SIDEWINDER
 \$45 PER PAIR

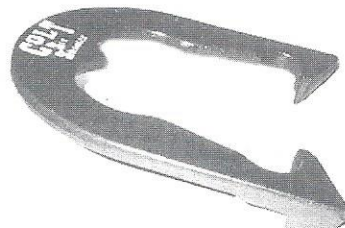

COLT SIX SHOOTER
 \$54 PER PAIR



BRONCO PRO-FLIP
 \$48 PER PAIR

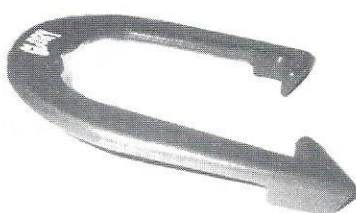

GLORY
 \$34 PER PAIR, 2 for \$59

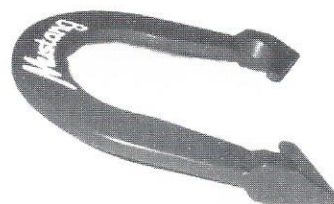

MUSTANG
 \$48 PER PAIR

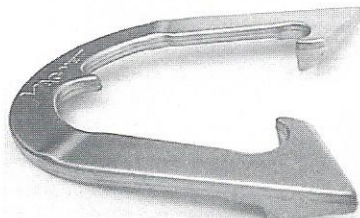

MAGNET
 \$45 PER PAIR

We have a complete line of accessories, shirts and caps for the game. Call for details on customized shirts for individual tournament players, clubs or leagues.

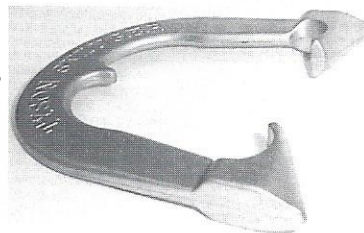

TYSON SWINGER
 \$54 PER PAIR

**ADD
 HORSE-
 POWER
 TO YOUR
 GAME!**

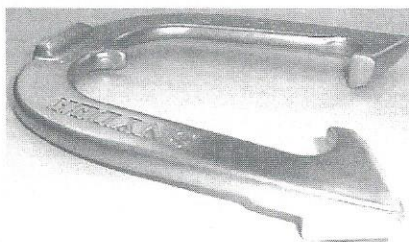

SNYDER E-Z FLIP
 2 models: with a ringer break
 (above) or without (not shown)
 Your choice: \$54 PER PAIR

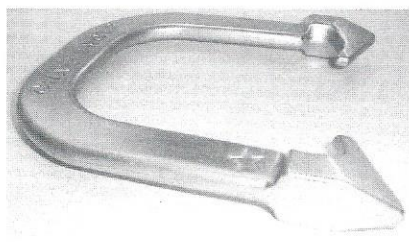

CHALLENGER
 \$39 PER PAIR, 2 for \$69!

**PITCH
 T-BRED
 SHOES!**

Toll free order line:
 1-800-841-4685

Accepting major credit cards



**WHITE
 DISTRIBUTORS**
 P.O. BOX 3652
 ERIE, PA 16508

All above models are available through any NHPA distributor
 Pennsylvania residents must add 6% sales tax when ordering direct from White Distributors

NHPA NATIONAL OFFICERS

PRESIDENT: DAVE LOUCKS, 6233 Woodman Dr., Lake Oroville, CA 95966 530-589-9818

1ST VICE PRESIDENT: ALLEN BAPTIST, P.O. Box 867, Eagle, CO 81631 970-328-1626

2ND VICE PRESIDENT: CASEY SLUYS, 1721 San Ramon Way, Santa Rosa, CA 95409 707-538-3128

3RD VICE PRESIDENT: LORRAINE STERNBERG, W206 N13520 Woodside Ln., Richfield, WI 53076 262-677-3300

4TH VICE PRESIDENT: BONNIE SEIBOLD, 1043 Grayston Ave., Huntington, IN 46750 219-356-3489

5TH VICE PRESIDENT: PAUL STEWART, 1043 Old Mountain Rd., Statesville, NC 28677 704-528-5081

SECRETARY/TREASURER: DICK HANSEN, 3085 76th St., Franksville, WI 53126 262-835-9108

PROGRAM & COMMITTEE DIRECTORS

GAME RELATED SALES: ED DOMEY, P.O. Box 298, Sutton, MA 01590 508-865-9477

JUNIOR PROMOTION: HEIDI STERNBERG, 1801 Lillian Dr., Hudson, WI 54016 715-381-3628

PUBLICITY/PROMOTION: 2nd VP, CASEY SLUYS

HISTORIAN: GARY KLINE, 605 Brantly Ave., Dayton, OH 45404 513-236-7206

NATSTATS: GLENN JAMIESON, 3231 Vineyard Ave., #17, Pleasanton, CA 94566-6359 925-462-6030

HALL OF FAME: EARL WINSTON, 10326 Highway D, LaMonte, MO 65337

REGIONAL DIRECTORS: 1st VP, ALLEN BAPTIST

SANCTIONED CLUB/LEAGUE: 3rd VP, LORRAINE STERNBERG

RULES AND BYLAWS: 4th VP, BONNIE SEIBOLD

GRIEVANCE & INSURANCE: 4th VP, BONNIE SEIBOLD

WEBSITE: 5th VP, PAUL STEWART

WEBMASTER: STEVE SUMMERLIN, P.O. Box 536, Webberville, MI 48892-0536

NHPA NEWSLINE

PUBLISHER / EDITOR: PAULA SUMMERLIN

DESIGN/PRODUCTION: ASAP PRINTING, Okemos, MI

PUBLISHER'S POLICY: NHPA *Newsline* is the official magazine of the National Horseshoe Pitchers Association. The contents may not be reproduced in any manner without prior permission of the Editor. Six issues are published annually on a bi-monthly basis. Back issues or additional copies of *Newsline*, subject to availability, are \$3.00 each postage included, \$5.00 for World Tournament issue.

ADVERTISING POLICY: The publisher reserves the right to refuse any ad. All ads accepted must be paid for in advance and meet specific format requirements. The publication of any ad is not necessarily an endorsement of the advertiser nor the featured product or service. Rate inquiries, ad copy and fee should be sent to

NHPA *Newsline*, Paula Summerlin, P.O. Box 536, Webberville, MI 48892-0536

LETTERS POLICY: *Newsline* welcomes communication and articles from the membership. Submissions should be provided on disk or e-mail in text format (MS Word preferable) or typed, double spaced and should include the writer's name, address and phone number. The editor reserves the right to accept or reject any letter or advertising material. All submissions are subject to editing, available space, and must be received by the first day of the month preceding the date of issue. Email address: psummerlin@cablespeed.com

SUBSCRIPTION POLICY: The annual subscription price is \$12.00 in the United States which includes postage via discounted standard mail. Add \$8.00/yr. for First Class Mail. Canadian subscriptions are \$20.00. All new subscriptions, renewals, payment and changes of address must be sent directly to:

NHPA, 3085 76th Street, Franksville, WI 53126
Phone/Fax 262-835-9108



Horseshoe Pitching NEWSLINE

Official Publication of the National Horseshoe Pitchers Association

CONTENTS

President's Message by <i>Dave Loucks</i>	4
Dave's Court Report by <i>Dave Loucks</i>	4, 5
Bylaws by <i>Bonnie Seibold</i>	5
NHPF News & Contribution Update by <i>Dave Loucks</i>	6, 7
Financial Report	7
Regional Director's Report by <i>Allen Baptist</i>	8
Club/League News by <i>Lorraine Sternberg</i>	9
A Visitor from South Africa by <i>Casey Sluys</i>	10
"What's Going On?" by <i>Cathie Loucks</i>	11, 12
NHPA Hall of Fame by <i>Earl Winston</i>	13
The Miracle of the Cards submitted by <i>Ed Quigley</i>	13
NHPA Publicity / Promotion by <i>Casey Sluys</i>	14
Focus on Promotion by <i>Bob Dunn</i>	15, 16
A Junior Promoting Juniors by <i>Heidi Poppe</i>	16
The Horseshoe Trader by <i>Bob Dunn</i>	17, 19
Mailbag	18, 19
Kenosha Horseshoe Club by <i>Harry Nelson</i>	19
2002 World Horseshoe Tournament Report	20, 21
Brooklyn Park Horseshoe Club by <i>Bob Dunn</i>	22
The Tri-County Horseshoe Pitcher Club by <i>Lu Cave & Rosie Leyk</i>	23
NHPA Internet Website by <i>Paul Stewart</i>	24
2001 Canadian Championships	25
2001 Ringer Classic	25
State and Provincial Tournament Results	26-29
The Toll of Time	30

PAID ADVERTISEMENTS

White Distributors	Inside Front Cover
Deadeye Horseshoe	5
Imperial Horseshoe	6
Mr. D Horseshoes	8
Bill Vanderburg Horseshoe Company	9
Ted Allen Horseshoes	10
Six Pac Horseshoes	22
Don Titcomb	23
Six Pac Horseshoes	24
Gordon Horseshoes	29
The Horseshoe Pitchers Companion	30
St. Pierre Horseshoes	Outside Back Cover

COVER

The Mayor of Red Deer, Alberta, Gail Surkam, presents NHPA President Dave Loucks with a red Stetson.

PRESIDENT'S MESSAGE

by Dave Loucks

The tragic events of September 11th will forever be ingrained in our minds, as will many of the visions associated with the senseless attack on our society. All of us had to be affected in some manner, but out of the grief has come a result that few could imagine. The country is now more united, more caring and more proud than at any other time since World War II. While we are deeply sorrowed by the loss of so many lives, we are now a nation determined to bring to their knees, those who felt they could tread upon us. Our prayers go out to those who lost family or friends and indeed to those who now take up the sword in a worldwide battle against terrorism. May God Bless America!

It was just 10 days after the attack that I boarded a flight for Calgary, Canada, to visit Red Deer for the required site inspection. While airport security was much tighter and the parking lots less full, the flights were booked solid as frequent travelers got back to their normal routines. Outside of longer lines and waits, I did not feel uncomfortable or inconvenienced by the added security precautions. I am one who enjoys flying and still feel it is

infinitely safer than driving.

Red Deer is a city of some 60,000 people, but it gave me the impression of a smaller community. It was very easy to get around and offered an abundance of motels and restaurants. These, as well as major shopping stores, are all located within a few blocks of Westerner Park, site of the 2002 World tournament. The pitching venue itself will take place in just a portion of the overall facility. We will be in two adjoining pavilions, both air-conditioned. One is scheduled to house 24 courts, the other up to 34 if entries warrant it. In front of these pavilions are two large rooms, sufficient to hold all exhibitors, office, check-in and awards space. To the side, is a large concession and public facility pavilion. Everything is on one level with easy access.

Outside, in front, is a large black top parking area. It is here, or on an adjoining lot, that some 100 temporary RV sites with power will be setup. Water and dump provisions may be provided by mobile trucks every few days. For those who don't mind a short 10 minute commute, the only city RV park and campground, alongside a river, is located a couple of miles away. This

park is very nice with solid pads, plenty of lawn and lots of trees. They normally do not take reservations, however, the Alberta/Red Deer committee has somehow managed to reserve 50 spaces for horseshoe pitchers. Two different lakes about 30 minutes drive, also have RV and campground facilities though I understand these generally reserve early in the year.

Another new building, part of the same Westerner Park complex will be the location for both the annual NHPA Convention and Hall of Fame Awards banquet.

Red Deer is located midway between Calgary and Edmonton, both of which have International Airports. If you plan to fly, rent a car at the airport and you are just one hour from Red Deer. There is much to do and see in Central Alberta. You will have many choices for a daylong outing, some nearby, some a couple of hours away. If you haven't been to this part of Canada, plan on attending the 2002 World Tournament in Red Deer. And don't forget, if the exchange rate remains about the same, your \$20 bill in the US will convert to \$30 Canadian.

DAVE'S COURT REPORT

NEWSLINE

I hope readers like the new font and magazine masthead which now puts stronger emphasis on "Horseshoe Pitching". The Council approved a change as suggested by New Jersey Regional Director, Ed Quigley. The actual masthead design was decided upon during my initial visit with new editor, Paula Summerlin and her husband Steve, who also happens to be the NHPA Webmaster. Congratulations to Paula. Her first issue, the 2001 World Tournament report, was great.

HALL OF FAME

After many years of being a dream and then with the formation of the NHPE, a plan, the Horseshoe Pitching Hall of Fame and museum is nearly a reality. Donations to the endowment fund helped gather the money necessary to start construction on the Joelton, Tennessee property donated by Dr. Jack Freeman. An approximate 900 square foot block building has been completed. Electricity and plumbing of

adjacent public comfort facilities is nearly complete. NHPA memorabilia stored for years by Earl Winston will be moved to Joelton before the year is out. Some professional guidance as to how best to display items will be sought. Showcases and various displays will be purchased or fabricated. Sometime in the spring of 2002, if all goes well, we plan to open the Hall of Fame. Thanks to all who have supported this endeavor. Don't stop now. Let's hope that others will get involved. The NHPF will continue to need your tax-deductible donations.

A PITCHER REMEMBERED

It is unfortunate but a fact of life that it often takes death for people to react. This is not meant in a negative sense but only to emphasize how people pull together for a common cause when a friend or loved one passes on. People want to do something in remembrance. Such was the case when Maryland member Randolph "Bud" Freeman died. Bud

Continued next page

DAVE'S COURT REPORT

Continued from page 4

loved the game and was delighted when he and wife Fran had the opportunity to visit the Joelson courts and site of the planned Hall of Fame. When Bud died unexpectedly, Fran asked that those who were so inclined to remember him by making a contribution in his name to the NHPF. Donations totaling \$670 were sent in by 18 friends and business associates. The NHPF greatly appreciates these contributions and extends to Fran Freeman both its thanks for the thought and its sympathy for her loss.

BYLAWS DEADLINE

If you want to propose a change to any NHPA Bylaw for consideration at the 2002 convention, remember that the deadline for receipt is December 31, 2001. All such proposals should be sent to NHPA 4th VP, Bonnie Seibold. Her address can be found on page 3 of this magazine or on the NHPA website under NHPA Officers. Proposals must be written referring to the specific article & section and a reason given for the proposed change. Not all proposals will make it to the convention. The Bylaw Committee will first review all proposals. Only those deemed to have merit and be of interest to a majority of the membership will be approved to come before the delegates.

BYLAWS

by Bonnie Seibold

The 2002 NHPA Convention at Red Deer will be when we vote on any proposed Bylaw changes. If you would like to submit any proposed changes, they will need to be sent to me and postmarked by December 31, 2001.

At the 2001 Convention, the delegates requested that from now on we present both the bylaw and rule proposals in a way that gives more information. They would like to know the reason for the proposal, etc.

If you are sending me a proposal, please give the following:

1. Reference to which article and section that you are proposing to change.
2. Exact wording
3. Reason for the proposed change.

This will help the delegates to better understand your proposal.



★ PITCHED BY CHAMPIONS ★

Price Per Pair
Up to 12 Pairs

CLYDESDALES	\$40.00
N.T.	\$40.00
REGULAR	\$40.00
E-Z GRIP	\$45.00
CLYDESDALE DF	\$45.00

(Write for greater quantity prices.)

**ALL "DEADEYES" IN
VARIOUS WEIGHTS OF
LIGHT - MEDIUM - HEAVY**

*Clydesdale now available in
"Extra-Light" weight 2 lb. 5 oz. or less.*

UPS shipping included in new prices—Continental U.S. ONLY

**All "DEADEYES" are
now available in Med. Hard**

**E-Z Grips and N.T.s are now guaranteed for
2 years from date of original purchase.**

N.T.s now have better hooks and more weight to the front.

**All other new sanctioned "DEADEYES"
are guaranteed one year.**

Guarantee valid in Continental U.S. only.

Broken Shoe Replacement honored by manufacturer only.
Return both shoes in original box.

Contact Bill Courtwright (ONLY) for special prices on
rejects and returned shoes (NO GUARANTEE) and not for
sanctioned tournament use.

NO SHOES WILL BE SENT ON CONSIGNMENT

Missouri residents add State sales tax.

Deadeye Horseshoes c/o W. Courtwright
2250 North Lark Dr., Fenton, MO 63026
Ph: (636) 376-5222 or (636) 677-2200 (8-5)

**Order direct or from
an authorized NHPA distributor**

NHPA NATIONAL BUYER
Edward A. Domey
P.O. Box 298, Sutton, MA 01590
(508) 865-9477

With construction finally underway in Joelton on the long awaited Hall of Fame building, donations to the NHPF become even more critical. The initial plans for a free standing building were downsized to a much smaller enclosure within the existing outdoor covered court complex to save money. However, costs are still expected to exceed \$100,000 before opening. In addition, we will then have the added expense of utilities, maintenance, higher insurance & taxes and the need of an onsite caretaker. Not only will we need donations to con-

tinue, but also hopefully they will increase. The Hall of Fame will open sometime next year. Plans are already underway to outline the next phase of the NHPF's charter to maintain it and perhaps begin to provide modest grants for court construction and/or increased financial aid to encourage greater junior involvement in the sport.

The seven NHPF Directors, who generally meet twice a year, continue to serve without pay and regularly cover their own transportation, lodging and meals to attend meetings. It is

all done for a love of the sport and a desire to see the game have its own pitching facility, Hall of Fame and museum. Like any charitable organization, the NHPF will continue to have operating expenses and the need for contributions to offset those expenses. It is therefore important that clubs continue to host fund-raising tournaments and individuals contribute whenever possible. Please send your tax-deductible donation to the NHPF Treasurer, 6233 Woodman Drive, Oroville, CA 95966 or the NHPF, P.O.Box 159027, Nashville, TN 37215.

Contributions received in March, April, May & June

Donating \$5-40

Art Moran, MN
Blind Pigs H.C., NC
Wm. Wordel, IL
Royce Keiser, CA
Ken Kundell, MD
Mallonnee family, MD
Wayne Ploughman, MD
Charles Bullock, MD
Jane Barthlow, MD
Shirley Hodges, MD
Gartrell family, MD
Wm. Tamblyn, CA
Gerald Schneider, CA
Bud Grisaffi, CA
Don Titcomb, CA
Emmett Schroeder, CA
Bill Brown, CA
Lyonal Clodfelder, CA
John Behrbaum, CA
Bill Dise, CA
Mel & Rosalie Judy, WV
Jerry Shifflett, VA
Portland H.C., OR
Barry & Barb Chapelle, OR
Fred & Karen Decorah, WI
Paula Hunsicker, TN
Cliff Holcomb, ID
Ron Steenburn, NY
Ray Welsh, OH
Denise Merkle, TX
Nelson & Sophie Clayor, TX
Shirley Jamieson, CA
Glenn Lang, OH
Stan Towne, NY
Indian Valley H.C., CA

Donating \$50-90

Gerald Presley, CA
Louis Engelhardt, TX
Fran & Randy Freeman, MD
Carrie Dillon, MD

Fogle family, MD
Roland & Eileen Merkle, MD
John Marchant, PA
Earl & Vicki Winston, MO
Ron Kohn, MI

St. Clair Shores H.C., MI
Matt Hardy, NJ
Diana Ratliff, PA
Kevin & Pat Snelgrove, VA

Continued next page

IMPERIAL

The Best Shoe for the Best Pitchers

Classic



**New
94
Notch**



Original



Plus



CALL FOR QUANTITY PRICES. 616-624-2861

Boyd Stonerock, 83441 CR 652, Lawton, MI 49065

Order direct or from NHPA Distributor

NHPF CONTRIBUTIONS *Continued from page 6*

Terry & Lorraine Sternberg, WI	Ken Schulze, CA	Missouri HPA	Banquet \$3820
Bellingham H.C., WA	Gordon Eatherton, CO	David Hooper, WA	Basics of Horseshoe Pitching Video sales \$500
Warren County H.C., NJ	Jim Mortinger, KS	Donating \$500+	
Southern Tier H.C., NY	Ed Arionus, TX	Emerald H.C., OR	
Donating \$100-190	Cajun H.C., LA	North Carolina HPA	1202 individual check con- tributions plus court fees,
Anonymous, WI	Sharon Reigel, MD	Hibbing H.C., MN	Banquet revenue, MMA inter- est & misc. cash donated
Mel Luther, NY	Brooklyn Park H.C., MN	Alice Siddens, IL	
Tri-County H.C., NY	James Crockett, OK	Donating \$1000+	
TCHPA of Sauk Rapids, MN	Stewlies for the NHPF	Oregon HPA	= \$161,090.66 deposited since program started in 1997.
West Geauga H.C., OH	Burly & Betty Burlingame, IA	3 months NHPA MMA	
Boyd Stonerock, MI	C.W. Gutshall, MO	Interest \$3054	
Whetstone H.C., OH	Donating \$200-350	Hibbing Hall of Fame	
	Dave & Cathie Loucks, CA		

How your state ranks in number and dollars contributed

1. Tennessee, 33 for \$18480	17. Iowa, 22 for \$2036	33. Oklahoma, 10 for \$388
2. California, 126 for \$11608	18. Pennsylvania, 35 for \$1914	34. Alabama, 3 for \$370
3. Minnesota, 117 for \$6521	19. Kentucky, 26 for \$1910	35. Idaho, 8 for \$335
4. Oregon, 42 for \$5766	20. Kansas, 21 for \$1782	36. West Virginia, 11 for \$320
5. Georgia, 15 for \$5725	21. New York, 29 for \$1581	37. Virginia, 11 for \$318
6. North Carolina, 59 for \$4938	22. New Jersey, 24 for \$1529	38. New Mexico, 4 for \$235
7. Missouri, 57 for \$4773	23. Indiana, 20 for \$1503	39. Arkansas, 5 for \$185
8. Wisconsin, 59 for \$4588	24. Nebraska, 19 for \$1318	40. Wyoming, 3 for \$182
9. Michigan, 69 for \$4392	25. Nevada, 9 for \$990	41. Arizona, 6 for \$164
10. Massachusetts, 7 for \$4015	26. Maryland, 24 for \$890	42. Hawaii, 3 for \$150
11. Colorado, 34 for \$3516	27. North Dakota, 6 for \$820	43. Alaska, 1 for \$120
12. Ohio, 67 for \$2986	28. Louisiana, 8 for \$767	44. New Hampshire, 2 for \$105
13. Texas, 30 for \$2935	29. Connecticut, 16 for \$537	45. Utah, 3 for \$100
14. Florida, 46 for \$2813	30. South Dakota, 12 for \$452	46. Vermont, 2 for \$50
15. Washington, 34 for \$2721	31. South Carolina, 10 for \$450	47. Delaware, 1 for \$7
16. Illinois, 46 for 2140	32. Montana, 6 for \$420	48. Mississippi, 1 for \$5

NHPA Income & Expenditures for August/September, 2001

INCOME

World Tournament Entries	\$665
W.T. Photos	\$1,000
W.T. Patches	\$70
W.T. Finals Fees	\$3,100
W.T. Class Print Out Sales	\$203
W.T. Unused Scorekeeping Funds	\$268
Newsline Subscriptions	\$4,352
Membership Dues	\$9,569
Sanction Cl/Lg Patches	\$21
Newsline Ads	\$300
NHPF	\$28
Firstar Bank Interest Money Market	\$1,834
Firstar Bank Interest Checking	\$450
TOTAL	\$21,860

EXPENDITURES

Newsline Printing Supplies & Mailing	\$128
Newsline Publication, Editing, & Miscellaneous	\$304
Sanction League Supplies & Telephone	\$40
All Junior Scholarship Trusts	\$1,579

W.T. Cash, Patches & Trophies	\$112,337
W.T. Travel Expenses	\$4,476
W.T. Administrative Costs, Printing, Office, Etc.	\$3,483
W.T. Refunds, Fees, Dues & Overpayments	\$300
Hall Of Fame, Awards, Supplies & Expenses	\$380
Regional Director, Postage, Telephone, Supplies & Printing	\$51
Equipment Purchases, Rental & Repair	\$771
Printing, Paper & Office Supplies	\$1,273
Postage	\$741
Officers Telephone	\$184
Officers Travel	\$104
Secretary-Treasurer Allowance	\$3,040
Presidents Allowance	\$912
Publicity, Promotions & Ads	\$1,151
Direct & Indirect NHPF Donations & Support	\$2,059
Professional Fees, Accounting & Legal	\$850
Misc. Fees, Bonds, Bank Charges, Etc.	\$77
Natstats	\$249
Internet Access & Web Site	\$554
TOTAL	\$135,043

REGIONAL DIRECTOR'S REPORT by Allen Baptist

NOTICE TO REGIONAL DIRECTORS

I am in need of approximately eight (8) 2001 State Doubles Class Champion patches. If anyone has any extra patches, please contact me.

I have been receiving an increasing amount of patch orders from tournament directors and Charter officers. I don't have a big problem with this, but I would like the RD's to inform their Charters that patch orders must come from the Regional Director. If not, the RD could end up with many more patches at the end of the year than are needed.

FROM THE MAIL BAG

Myrtle May Kamoku, Hawaii RD—reports that 60 pitchers were entered at the State Singles Championships this year. Myrtle also has had a few horseshoe pitching tourists come over from the mainland to enjoy the island of Kauai's pitching and hospitality. Jerry Shene from Michigan, myself and Rich Pintor and family made the journey from Colorado this year. The Pintors were on the island for a very special occasion. Lisa Pintor was married in September. The Pintors spent an extra week on the island due to the terrorism attack in New York.

Elwyn Cooper, Missouri RD—reports that Missouri has sanctioned 77 tournaments thus far in 2001. New Melle, Liberty and Park Hills combined could have an additional eight tournaments this year.

Ed Quigley, New Jersey RD—reports that NJ ARD, Bob Brown has sanctioned new courts in Gibbstown. Bob says that the courts are very nice, and there are plans to add more courts in the future.

Randy Collins, Texas RD—reports that two new clubs, the Bryan and Tri-County clubs, have hosted their first tournaments with great turnouts. Randy also states that the Bryan club is currently adding eight more pits to their facility.

Lance Twyman, New York RD—reports that the Forestville Flingers have recently added six new courts with full walkways. They also have the

room to add more courts in the future.

Gail Sluys, Northern California RD—reports that she has sanctioned 16 beautiful courts belonging to the Tri Valley Club. The courts have full concrete walkways with grass between the courts.

Bernie VanLerberg, Kansas RD—reports that the Edgerton Horseshoe Club has built nine new courts just off Interstate 35 at Martin Creek Park. The courts have concrete walkways, fences and lights. The courts currently have

sand but will have clay next year. There are plans to add nine more courts to the current nine. Bernie says that the town of Iola, which has a small but growing horseshoe membership, is expecting to build some courts and host some tournaments in the new future.

Don Conklin, Colorado RD—reports that he has sanctioned six courts called the Miners Park Horseshoe Complex located in the town of Firestone.



MR. D HORSESHOES

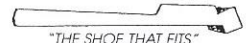

"THE SHOE THAT FITS"
DESIGNED AND BALANCED FOR THE FLIP



<http://www.geocities.com/mrdshoes>

— Order Direct From —
MR. D. HORSESHOES, BOX 394, POST, TEXAS 79356



JOHNNY DAVENPORT
806/495-2630



MASTERCARD & VISA ACCEPTED

or Order from:
Your NHPA Representative
EDWARD A. DOMEY 508/865-9477
P.O. BOX 298, SUTTON, MASSACHUSETTS 01590

THE TOE OF THE MR. D SHOE IS SMOOTH WITH A GOOD SLANT ON THE TOP SIDE FOR AN EASY GRIP AND A SOFT TOUCH DELIVERY

THE CALK ON THE BOTTOM OF THE MR. D SHOE WILL INTERLOCK ONTO THE TOP OF THE FIRST SHOE PITCHED, TO HELP PREVENT THE SECOND SHOE FROM REBOUNDING BACK OFF THE STAKE

THE BALANCE AND THE INTER-LOCKING FEATURE OF THE MR. D. SHOE IS PATENTED



\$50 per pair
Postage paid to the 48 contiguous states
Texas residents add \$3.63 sales tax
PATENT NUMBER 5,704,857
— L-M-H Weights —
With or Without Ringer Breaker
CAST FROM ALLOY STEEL
Guaranteed one year against breakage
NO SHOES SENT ON CONSIGNMENT

ARE YOU TIRED OF FLIPPING A SHOE THAT IS DESIGNED TO BE TURNED?

*"Your MR. D. Shoe is the best thing going! I was carrying a 43.1% average, but after getting a pair of MR. D.'s and some practice, (it did take a little while to get used to the MR. D.'s) that 40+% is a thing of the past. I took 2nd Place in Class 'B' State Singles, with a 48%, highest % for me to that date.
I am now holding a 54.6% and pitching in Class 'A'! Even though I still struggle through some 40-50% games, I also have a lot of games in the 60-70% range. With a little more time on the courts, I expect my % to keep climbing!"*

*D. Mc
Colorado*

*"... Just for your information, I am an amateur horseshoe pitcher, having only joined a league two weeks ago. At one of the meetings, I had the pleasure of throwing some of your MR. D. shoes.
Being new to the sport, I never dreamed that different shoes could make a difference! For the three games I used your shoes, my ringer percentage was double my usual average.
I simply had to get a pair of your shoes after that experience (much to the chagrin of my wife!)"*

*T.S.
Kansas*

*"Dear Sir,
I would like to order a pair of your MR. D. Horseshoes. I am a 30 foot pitcher, and my ringer percent is 56%. I have a lot of ringers flip off the stake. I hope the MR. D. shoe helps."*

March 14, 2001

*"Dear Johnny,
I received my pair of MR. D. shoes today, and, of course, I had to try them out. After I got used to them not having a toe lug, I thought I would see what ringer percent I would get out of fifty shoes.
The first fifty, I got 72% - the next fifty shoes I got 74%. The last fifty I had 82%!!! I sure like the way they flip and land!"*

March 23, 2001

*"Johnny,
I have been to seven tournaments since I started using the MR. D.'s, and I've won four! I hit a lot of 70 plus % games!
I am enclosing a check for fifty dollars for another pair of MR. D.'s as my back-up. Thanks."*

June 24, 2001

*B.T.
Ohio*

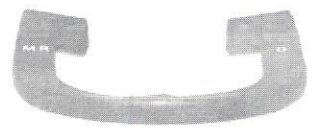

SANCTIONED CLUB/LEAGUE **NEWS** by Lorraine Sternberg

It's hard to believe that the end of another horseshoe season is past. It seems like we had barely started pitching league when before one knew it we were finished. Time seems to go by just a little faster these days.

I would like to thank all the league directors who have gotten their reports in on time. I am receiving reports in a timely manner with all the completed information I need for Natstats and myself. This saves me a lot of time by not having to contact league directors for missing information. Remember, do your final stats reports right after the season is over and it will not be pushed aside and forgotten about. Please note that I do not send out patches after the first of the year for the previous year. If you are on-line, you can do your reports by e-mail. It works great and I can get your patches out to you so much quicker.

Deadlines for the Top Ten report and the Junior Scholarship are fast approaching, so get these forms in to me if you have not done so yet. You could be leaving one of your league pitchers out if you don't.

THOSE CLUBS THAT ARE RECEIVING CONSECUTIVE SANCTION AWARDS THIS YEAR ARE:

1997-2001 (Five years) Forebay Park HSC, California; New Haven HSC, Connecticut; Whiting HSC, Indiana; Pony Express HSC, Missouri; Gate City Clangers HSC, New Hampshire; Minot HSLG, North Dakota; Arledge's Six Indoor HSC, Ohio; Little Rhody HSC, Rhode Island; Southern Hills HSC, Virginia and Sandbar Sandbaggers HSC, Wisconsin.

1992-2001 (Ten years) Tri-Valley HSC, California; Greater

Danbury HSC, Connecticut; New London County HSC, Connecticut; Barbers Point HSC, Hawaii; Madison County HSLG, Kentucky; Baltimore Metro HSC, Maryland; North Star HSC, Minnesota; Festus HSC, Missouri; New Melle HSC, Missouri; Lions Park HSC, Missouri; Black Swamp Tues. Night LG., Ohio; Fannie Mae HSC, Texas; Bureau Valley Jr. LG., Illinois; and West St. Paul Jr. LG., Minnesota

1987-2001 (Fifteen years) Joliet HSC, Illinois; Marion HSC, Indiana; Platte Valley Pitchers HSC, Nebraska; Sheyenne Valley HSC, North Dakota; May-Port HSC, North Dakota; Yukon HSC, Oklahoma; Spearfish HSC, South Dakota and Sweetwater County HSC, Wyoming

1982-2001 (Twenty years) Indian Valley HSC, California; Boulder HSC, Colorado; Peoria HSC, Illinois; Golden Triangle HSC, Missouri; Syracuse Pioneer HSC, New York; Red River Valley Mixed HSLG, North Dakota and Dormont HSC, Pennsylvania

Congratulations and thank you to all these clubs and leagues for their continuous support to the National Sanctioned Club/League Program.

We look forward to 2002. This will be the 25th anniversary of the Sanctioned Club/League Program. Let's make this a silver anniversary to remember. Thanks to Lu Cave and Roise Leyk for submitting their article on the Tri-County Horseshoe Pitchers Club. The Tri-County Club is one of the charter clubs.

May you all have a Blessed Holiday Season!

BILL VANDERBURG HORSESHOE COMPANY

30 Avalon Place, Unit 201
Kitchener, Ontario, Canada
N2M 4N6

(905) 567-9717
(519) 575-9163



CAN-AM: (CAST) A super shoe for the three-quarter turn, one-and-a-quarter and one-and-three-quarter turn. L-M-H

VIP: (CAST) Designed for the flip and the three-quarter turn. Has a good heavy lug. Thrown by the Canadian Women's Champ 1993 at 80.1%. Thrown by the Junior World Champ 1996 at 82.3%, 1997 at 78.5%. Weight - L-M-H. You'll love them.

CONDOR: (CAST) Designed for the flip. Perfectly balanced. (Thumb indentation.) Can be thrown up or down. Lugs down. Weight L-M-H. Super in flight.

PRO-STAR: Designed for the flip, can be thrown up or down. Weight - L-M-H (New thumb indentation.) Second to none.

PRICE: \$43.00—Shipping & Taxes extra. 1 year guarantee. Order through your NHPA Representative.

A Visitor from South Africa by Casey Sluys

While perusing the guest book of the Northern California Horseshoe Pitcher's website in January, I noticed a fellow from South Africa had signed the book. Answering him for nothing more than striking up a conversation, we began a correspondence that led to an eventual meeting, if you can believe that?

This is how it began:

Name: John Kriel

Hometown: Cape Town, South Africa.

Sent: January 25, 2001

We have just started playing this wonderful game and now, having visited the website, feel more encouraged in now knowing the rules. We are a group who go out in our trailers (Caravans) every month and have found this to be the ideal game for us. Regards from Sunny South Africa. John.

P.S. I will be in Las Vegas in May from the 2nd to the 8th. Let me know if there is any action in this area at that time.

When I heard that John would be in Las Vegas I was ecstatic! That same weekend the "Best of the West" tournament was being held in Beatty, Nevada a mere 120 miles away. Gail and I had planned on going to Beatty to pitch and see our friend Don Weaver. (For those of you that are curious, Don is looking good and is his usual ornery self.)

Thinking of meeting John for the first time gave me all kinds of ideas for the promotion of horseshoes in South Africa, a country about as far from us as you can get. I took 30 copies of the rules, 30 copies of the NHPA brochure, a few NHPF brochures, some articles on "How to Pitch Ringers," a couple of books by Steven Boga entitled, "Horseshoes," "The Basics of Horseshoe Pitching" video, a couple of patches, some window decals, and of course two pair of American horseshoes. There were a few other items that I neglect to mention, but you get the general idea.

These are the kind of items other countries do not have or even have access to. With the advent of the Internet and online buying, it has become easier for those in far away places to reach us. However, there are most likely very few third world countries connected to the

Internet? (See Togo article)

We departed Santa Rosa on Thursday morning and arrived in Beatty in the late afternoon. Early Friday morning we left for Las Vegas to meet with John Kriel. He had told us where he would be staying in Las Vegas and we had agreed on a meeting between 9 and 10 a.m. Upon arriving at his hotel I called his room and after no answer had him paged. While on the courtesy phone waiting for the page a fellow walked down the line of people on other phones. Glancing at his name-tag I noticed it was John, hung the phone up, stuck my hand out and said, "John Kriel." He immediately shouts out, "Casey glad to meet you!" After a few pleasantries and introducing him to Gail, we walked to where I had parked the car.

Due to a hotel mix-up on his convention times our meeting was rather short. I wish we could have had breakfast, but his convention was in progress and he needed to be there. While standing at the trunk of my car where the literature and the horseshoes were, I explained the literature to him. I showed him the various types of horseshoes we had with us, let him hold each type and swing them. We took a pair back inside the hotel so Gail could take a picture of us making the presentation to him. Unfortunately our meeting lasted only about one hour, if that.

John came all the way to Las Vegas for a convention of Bossons Character, head people from Germany, Holland, Australia, South Africa and other countries according to John. It's a little known orga-

nization that goes by the name of International Bossons Collectors Society. They meet once a year in a different state of the USA. Check out their website at <http://www.bossons.com/> It's simply amazing what a person can learn by simply striking up a friendly email conversation!

This is his reply to my email after our meeting...

Hi Casey, Here I am, back home and tired after my travels. I have not been out with the gang here yet, but we will all be together for a week from Monday morning. The Video was tops. I can't wait to show it to the other guys. I had no trouble going through customs at all. I have been attending the conventions since 1994, and can't wait for the next one. Thank you once more for your generosity, and will keep you posted on developments here. Cheers to your good Lady and your fellow club members,

Pitch ringers, John.



Ted Allen Horseshoes

Since 1938

**Designed and pitched by the
10 Time World Champion and
record holder of 36 Consecutive
Doubles (72 ringers)**

Dead Soft Medium Soft Medium Hard

Various Weights & Colors
2 year guarantee against breakage

Ted Allen Horseshoes, Inc.

13299 E. County Line Rd
Longmont, CO 80504-9797

1-800-883-2129

tahico@aol.com



“WHAT’S GOING ON?”

Dear Newslite Readers,

The new editor, Paula Summerlin of Michigan, has asked me to write a column similar to “Shoe Bits,” which I originally authored as “Maynard,” prior to it being taken over by Mr. Kilgore. (Maynard was my nickname throughout my school years) I will endeavor to provide you with some interesting tidbits from charters throughout the country. However, I can do so only with your cooperation, which means I will need your contributions.

Editors, please send me your charter newsletters. Readers, please send any current information regarding your charter and/or members you think might be of interest to our subscribers. Send this information to: Cathie Loucks—6233 Woodman Drive, Lake Oroville, CA 95966 or email at cc@cncnet.com (Note: If you already send a newsletter to Dave Loucks, there is no need to duplicate.)

I sincerely hope you will enjoy “What’s Going on?” ...

Cathie Loucks

CALIFORNIA (NORTHERN)

Congratulations to Dave Loucks on his re-election as NHPA President. Dave has appointed Casey Sluys as NHPA Publicity/Promotion Director to replace Billie Sue Pennington who has resigned to go back into retirement. The State Tournament, held at the Yolo, 40+ court complex in Davis, crowned champions in 5 divisions: Men, Nathan Williams; Women, Sharon Paddock; Elders, Leldon Day; Boys, Keith Boone and Girls, Amy Horton. In the works: current maps and driving directions to all club pitching facilities will be added to our website. A reporter for “Evening Magazine,” a nightly TV show aired on San Francisco’s Channel 5, issued a challenge to Gail Sluys for a game of horseshoes. The challenge game was filmed at Gail’s home courts in Santa Rosa on Oct 9th and will be aired on the “Outdo Maliu” segment of the program sometime this fall/winter. The California Police & Fire Games, held annually throughout California, were hosted in mid-August by the San Jose & Tri-Valley clubs in Pleasanton, the site of the 1988 W.T. This is an excellent way to gain not only publicity but also, new members. You can contact the Police Athletic Federation in your state to volunteer to host an event.

COLORADO

Congratulations to Paul LaCrosse, 4th runner-up in the 2001 W.T., on his 18th State Championship. He had to beat Dan Martinez in a play-off game for the title. Hats off to Jim Tulk who has qualified 38 times for Class A in the 50 times he has competed in the State Tournament. Robert Gentry won Jr. Class A with a 6-1 record and a 25.8% average. Doug Moe prevailed over Class B with an 8.9% and a 5-1 record. They competed in a field of 11 juniors at a summer tournament in Edgewater. Awards abounded at the annual banquet and presentations which included: Hall of Fame Award for Service to Alan Baptist; Presidential Award to Ed & Jan Knaub; Ted Allen Memorial Award to Lee Stevenson; Arch Wood Sportsmanship Award to Bob Goodhue; Janie Thompson Jr. Scholarship Award to Ben Elich; Double Ringer Achievement Award to Rick, Joleene and Noah Elich (for special work with the junior program); Decade of Service Award to Paul LaCrosse.

FLORIDA

Norm Gaseau, a retired U.S. Coast Guard Captain, has been an active and productive member of the NHPA, the

Clearwater Club and the FSHPA since the time he joined in 1969. At age 86, Norm was still serving these three entities as; Chairman of the FSHPA Hall of Fame Committee, administrator of the FSHPA Hall of Fame exhibit and Sec/Treas. of the Clearwater Club. His accomplishments are just too numerous to list. All the members sincerely congratulate him on his well-deserved induction into the NHPA Hall of Fame in Hibbing, MN.

Edwin Fox, Publicity Chairman, invites all you horseshoe pitchers vacationing in Florida to come over and pitch with them at Beverly Hills.

They have five tournaments scheduled from November through March with the one in March being a Junior Scholarship Tournament to raise money for the Florida Junior Scholarship Fund. An extra \$5.00 is added to the entry fee, which will be turned over to the Florida Junior Scholarship Fund. Person to contact for Beverly Hills tournaments is Linda Kaercher, National Tournament Director, 6051 N. Speckled Perch Terrace, Hernando, FL 34442-3965 Phone 352-726-1780

GEORGIA

If you watch the Thursday night airings of TBS’s “Man Made Movies,” and didn’t switch channels at the commercial breaks, you probably saw the construction of horseshoe courts at the house being built for “guys.” Al and Iris Sandham were featured in the episode, showing the courts being built and Iris pitching. It was scheduled to be aired during the commercial breaks of the feature movie on Nov. 1st at 8:00 p.m. There was a daylong film shoot on October 3rd. This was all part of a special TBS filmed showing all the things guys would want built in a house just for them. If you missed it you might still be able to check the GHPA web site for a picture review of the film shoot.

IDAHO

Earlier this year Idaho president, Dave Spears, was selected to give an information speech to 200 people at Boise State University. He chose horseshoes as his subject and proceeded to share extensive information about our sport to the assembly. He had business cards printed with some general horseshoe pitching information, which he distributed after his speech. Jeremy Bengston, Bill Rust and Carlene Shove have resurrected the club in Coeur d’Alene.

Continued next page

The club members, working together, have refurbished the pits and look forward to holding tournaments. (Maybe they'll have a warm-up tournament for those going to Red Deer in 2002.) Kudos to Jonell Goss on her 1st "Four Dead" newsletter.

IOWA

The permanent Hall of Fame display at the Iowa State Fair has been put out to pasture. This display has been overseen by Earl & Vicki Winston and the Iowa Assn. for many years. Iowa will be purchasing a trailer for their display. It will be parked next to the courts during the fair, but will now travel to other locations as needed.

MISSOURI

The charter's annual donation of \$250.00 to the NHPF was increased to \$320.00 due to various donations made at the State Tournament. A \$2.00 per member dues increase was approved at the annual meeting, as was the purchase of a storage trailer to house the MOHPA-owned 32 portable courts and rubber mats. Looks like the MOHPA has every intention of recapturing the "largest membership award" from MN and also possibly winning the "largest increase in membership award." Fifty-plus new members had already been recruited by mid-year. These NHPA awards are presented at the Hall of Fame Awards Banquet held during the World Tournament.

NEW JERSEY

Joe McCrink, who ranks 3rd in the country with an 80.8% average, pitches right-handed. However, he writes and plays tennis, ping-pong and badminton left-handed.

OKLAHOMA

The unused tennis courts of Broken Bow no longer exist. The site is now home to 12 horseshoe courts thanks to Tom Wilkinson and VP, Philip Morris. They are getting great participation from Texas and Arkansas pitchers at their tournaments. Although Oklahoma was outgunned in the 6th annual TX-OK Shoot-out, held in Denison, TX, they still lead with a 4-2 record. Laura Downum of Miami was voted Olympian of the Year in Oklahoma by the State Senior Olympic Committee. She has been competing in horseshoes and track and field for over 10 years.

OREGON

Thanks to the combined efforts of Jerry Gorton and the Oregon pitchers, the NHPF Benefit Open raised \$475 for the NHPF. Also an ongoing raffle throughout the State raised another \$602 for the Foundation. The drawing was held at the State Tournament and was won by Carl Kaiser of Iowa who bought a ticket while visiting in the area.

Lloyd Kilgore, who edited & published the first 4 editions of Newslines this year, resigned while attending the World Tournament in MN due to continuing health problems. Rudy Braun of Gresham has spearheaded the effort to have indoor horseshoe courts included in the new Sports Park. Groundbreaking was in July for the 33 acre development.

Congratulations to Barry Chapelle and LaVeme Ewing. To LaVerne for repeating as Women's Champion and also on her Dec 1st wedding. To Barry for finally winning the Men's title—it's been a long time coming.

PENNSYLVANIA

Congratulations to Kurt Von Kleist, who although only managed a 2nd place finish at the Frank Kallay Memorial, pitched a perfect (16 shoe) game. He was the 6th PA pitcher to do so in tournament play and received a \$100.00 WHPA award for his accomplishment. A new PA Sports Hall of Fame facility to be built on Harrisburg's City Island will house an area devoted to horseshoes due to the efforts of Judge John Brosky. Frank Bohun of Erie received the Al Zadroga Memorial Award after winning all three of the eligible tournaments without losing a single game.

TENNESSEE

Shannon Foster won his 5th title as Men's State Champion after defeating Elmo Cox in a playoff game.

Maxine Griffith captured her 8th title as Women's Champ, Dexter Stallings, the Elder title and Jordan Johnson the Jr. Boys title. Gold Medals for horseshoe pitching were presented to Hugh & Jean Hinkle and Joyce Manis at Senior Olympic Games this summer. Congratulations to Mary Ella Bastian on her well-deserved induction into the State Hall of Fame. Joan Elmore set a world record this summer at the Greenville Ringer Classic when she pitched 52 consecutive ringers. (WOW!) She and Sylvianne Moisan set another world record when they pitched 13 consecutive four-deads. A few weeks later she took 5th place in the Women's Championship class at the W.T. averaging 78.19%.

WASHINGTON

The entire state was saddened by the death of 3rd VP, Joe Wolf. Joe, a dedicated supporter of horseshoes in Washington, was also a founding member of the Bismarck, ND club that hosted the 2000 World Tournament.

Russ Phillips is to be congratulated on his first performance in a W.T. He pitched against several former World Champions in Class A and managed victories against Dale Lipovsky and Walter Ray Williams, Jr.

WSHPA president Phyllis Quist questions the theory that a hole in the ozone layer is the cause of our atmosphere heating up. Her theory is that all the iron in horseshoes is attracting the molten lava in the earth's core and pulling it to the surface and thus creating the unbearable heat we seem to attract at every world tournament. (Not a bad theory!)

WEST VIRGINIA

Charles Bunner, who has been a driving force in WV horseshoes for many years, is stepping down at year-end from his position as secretary/treasurer due to serious health problems. He was instrumental in writing the constitution & by-laws that was adopted by the charter some years ago. Charlie did all the leg-work on the W.T. bid awarded to WV and tried for years to convince the powers-to-be of Marion County and the State to build a NHPA Hall of Fame & Museum. He is constantly promoting our sport and it seems he manages to get an article on horseshoes printed in his local paper just about every week.

WISCONSIN

Jim Haupt, Regional Director, recently underwent heart by-pass surgery. The report is that he is back home, and on his way to recovery. If you would like to send him a card, here is his address. Jim Haupt, 5075 N. Elkhart Avenue, Milwaukee, WI 53217.

NHPA HALL OF FAME

by Earl Winston

Hello again! It's been awhile since I've been in touch through the pages of *Newsline* and it's good to be back. This is an exciting time in my life, because at last a dream is being realized. A building has been constructed in Joelton, TN to house the NHPA Hall of Fame and Museum. Items that you have been contributing over the past several years are now going to have a permanent home. Even though I spent only four days at the 2001 World Tournament in Hibbing, several of you caught up with me and gave me additional items to add to the collection. Now that there is a place being made ready to display some of our sport's history, I'm sure that even more contributions will be received in the near future. I will be taking much of the material to Joelton, TN sometime in November. However, it will be several months before the building will be ready to open for visitors.

I would like to take this opportunity to tell you about one very generous donation that has been given to us; something that has taken thousands of hours and a good deal of expense to compile. More than a dozen years ago, a quiet fellow from Massachusetts decided he had some spare time and he would attempt to put together a history of all World Tournament competition from any records he could find. The first year is either 1909 or

1910. His intent was to list each participant who ever competed in a World Tournament, along with their stats for that tournament and the class they pitched in. Now the early tournaments were pretty easy with only one or two classes. But then we get into later years when we start getting into the hundreds of participants and then went even higher, reaching over 1,700 participants one year. This was going to be some huge undertaking. The name of this brave individual is Bart Sargent. Bart is small in stature, but has a giant heart and a lot of determination. Armed with only a word processor to record his findings, he began his task.

It took a few years of research, phone calls and letters, but at last Bart had a finished volume to display. If anyone had ever pitched in a World Tournament in the years he could find any records, their name was in the book along with what stats he could find for their performances. He sent me one of the first completed volumes to use in my work with the Hall of Fame Committee. It was a very, very thick notebook. Each year you could find Bart at a small table somewhere at the World Tournament site, eager to show off his work and ready to talk horseshoe history with anyone who stopped by to visit. I believe one goal was to sell some of his books to help defray his expenses. Whether or not that ever hap-

pened, I don't know. As the years went by, Bart continued to update his work through the 1999 World Tournament. He did some other things like listing players and showing their performances against other players over the years. He compiled lists of all time performances, high games pitched in World Tournament play, etc. He continually checked and rechecked his work trying to get it as accurate as possible.

During this past winter, while I was ill and then recuperating from surgery, I received two separate shipments from Bart Sargent. He was donating a total of 4 volumes of his hard work to the NHPA. He asked for nothing, not even reimbursement for postage. He has done this because of his love of the sport. Bart says he never got too proficient at pitching, so decided maybe he could make a better contribution by staying off the courts, or something to that effect. Contributed he has! Hopefully a way will be found to preserve the information these volumes contain in the same way that libraries preserve printed material on microfilm or by some other method. The records contained in these volumes will be of great interest to many who visit the Hall of Fame and Museum in the years to come. Thank you, Bart Sargent. It is hard to properly describe the magnitude of your donation in this short article. We salute you!

The Miracle of the Cards

submitted by Ed Quigley

Craig Shergold of England is alive and well and soon will be the subject of a made-for-TV movie about his miraculous recovery from cancer.

Long-time readers of *Newsline* may remember Bob Dunn's "Junior Jottings" article in the May/June 1992 issue that told about Craig's terminal brain cancer and his ambition to be included in the Guinness Book of World Records for the largest number of business cards collected by one person. His mother made a public plea for get-well cards to be sent to Craig as an incentive to keep him going in his

struggle against the cancer.

The response from horseshoe pitchers and others was extraordinary. Craig got a spot in the Book for being the recipient of the most cards—350 million and counting.

Craig Shergold's remarkable story of recovery is told in "The Miracle of the Cards," which will air 9:00 to 11:00 p.m. November 10th and again on Thanksgiving, November 22nd on the Pax network. The movie's premise is that one of those cards resulted in a miracle. It might have been one of yours!

Please allow me to thank Billie Sue Pennington for an outstanding job these past three years as Publicity Director. Having known Billie Sue for the past 15 years and having served with her in the Northern California as a fellow Charter officer, I can tell you that this fine lady has worked tirelessly toward bringing horseshoe pitching to the public and bringing it up to 21st century standards. She has offered any assistance that we may need and pledged to help us whenever necessary. Rest assured Billie Sue, you will be called on numerous occasions. Billie Sue has offered to continue processing newspaper articles and pictures for the Publicity website.

In this article I would like to introduce you to a couple of people that will be assisting with the combined Publicity/Promotion position. First of all to help with promotion efforts, Dean Schmitz (Michigan) has accepted the position of Assistant Promotion Director. Dean has developed a clinic presentation outline for the public that virtually anyone can use. It is a compilation of material readily available to anyone that visits our website. It has simply never been brought together under one cover or presentation; that is until now. The person named as Assistant Publicity Director is Kevin Smith (Michigan). Kevin was the contact between all manner of media and the NHPA at the 2001 World Tournament. He was called upon to perform these duties when Billie Sue was unable to attend due to family illness. He was successful in achieving the cooperation of the local Hibbing, Minnesota newspaper and getting daily results printed. He constantly kept track of various newspaper and television reporters that came to cover the event. Kevin also videotaped the Championship groups, edited the tape and sent it to the David Letterman show. Both of these men will make fine additions to our Publicity/Promotions team.

To all of you who picked up the horseshoepitching.com bumper stickers at the World Tournament, we hope you have had a chance to give them away to your Charter members. If you

still have some in your possession, please give them out and stick them on your vehicles. They are vinyl and will come off without damaging the paint or chrome. When people see them, undoubtedly they will ask questions. That is when you can become a spokesperson for your club. Brag about it, tell them what a great bunch your club is and explain horseshoes to them. Those that visit our website will see that we are indeed very organized and that there are Charters throughout the country. Anyone needing bumper stickers can write me and I'll be happy to send as many as you can display.

One of the first goals we envision for our team is to establish contact with all Charter Newsletter editors, so that we might publish ideas in those newsletters and make all Charter Members aware of what Publicity/Promotion tools are available. Secondly we hope to establish a resource library in which video clips of top pitchers, a variety of "how to" videos, the promotion kits, pamphlets, plus things we haven't even thought of yet would be kept. These could then be loaned to anyone wishing to make a presentation to any organization such as Rotary International, Lions Clubs, Elks, Boy/Girl Scouts, church groups, Parks & Recreation Departments, etc. One day we hope to have a professionally done video covering all aspects of horseshoe pitching, from building courts to becoming an 80% pitcher.

I would like to ask all the Charter newsletter editors to please begin sending me a copy of your Charter newsletters. It would be greatly appreciated. We will read them all and garner publicity/promotion ideas for all of us to use on a National level. Those ideas that have proven fruitful will be posted on the website for all to read.

Currently we have requests for video footage of horseshoe pitching. If any of you have some recent footage and would like to donate it to our library, we would be most appreciative.

We need ideas and contributions from each of you. Please email or send your ideas for publicity/promotion to us. Remember, it is your organization and to make this project flourish we

need your help. Any idea, no matter how far fetched, is fodder for us and we will attempt to build an active and larger membership off those ideas.

Thank You,
Casey Sluys
1721 San Ramon Way
Santa Rosa, Ca. 95409
(707) 538-3128
kcslus@worldnet.att.net

SPECIAL EVENTS CALENDAR

PROMOTE YOUR SPECIAL EVENT HERE.

If your tournament is set
apart from the usual,
to benefit charity,
raise funds or has
in excess of \$1,000
prize money,
mail details to the
"Horseshoe Pitching
Newsline" Editor
at least 90 days
in advance.

FOCUS ON PROMOTION

How is 'Promotion' Going? Check the Score Card by Bob Dunn

As pitchers wish to evaluate their performance they can check the score sheet during a game or the leader board at a tournament. A player can compare his average against his goals, previous performances and many other various ways to assess how their game is going.

Why not the same in promotion activities? A review or evaluation can be established, we just need to develop a scorecard. A scorecard can be established by an individual, league or charter.

Why do this? How else can there be clear evaluation of progress. Just as score sheets and statistics are vital in a player plotting his or her progress, so is it vital in viewing our promotion evaluation. How else can one know how they're doing, unless they know where they are going.

This review process will require developing a scorecard. That will require some forethought and declaring what items, projects and assignments should be accomplished. Almost sounds like—making out a plan.

How can a scorecard be established? Examples are provided. The most critical of these is the league scorecard. This is where new members are introduced to the sport. This is where the orientation to our sport takes place. This is where members learn the proper method for scorekeeping, learn game rules and are invited into tournament play. The league level is the most critical area for review. An individual member scorecard is also important, for here is where we receive the direct contribution of effort to our sport and our organization. The charter scorecard is also necessary, as here is where we monitor the support and resources to our major promotion efforts.

I hope that this article has some appeal to the national officers. What if an official point system is established and as an individual reaches a set number of earned points, that member

would earn and receive a *NHPA PROMOTORS' CLUB* patch.

That same recognition concept could reach out to clubs who earned points to receive a *NHPA STAR CLUB* plaque.

The foundation of self-appraisal of promotion gets right back to an issue that has been written numerous times in this series—an individual, a league or a charter must list what needs to be done before there is focus of what to do or how to do it. Without a scorecard, how else can we know—"How are we doing?"

PROMOTION JOTTINGS

For over five years, each Focus of Promotion article has been followed by a brief look back into our sport's history. Many positive comments were received during my visit at the World Tournament in Hibbing about how enjoyable these exerts of history are. Those comments are certainly appreciated. The following history profiles of Indiana and Maryland are from the 1940 NHPA Horseshoe Compendium:

INDIANA—Officers of the Indiana Division, National Horseshoe Pitchers' Association are:

Continued on page 16

EXAMPLE REVIEW SHEET FOR CLUB SELF APPRAISAL

Point Value	Date for Completion	Project Item	Points Earned
25		League is National Sanctioned	
10		Has each member been handed a rules brochure	
5		Has each member been handed a Newsline subscription form	
5		Has each member been invited to participate in the state tournament	
5		Has each member been invited to participate in the World Tournament	
5		Does the league use the NHPA approved scoresheet	
5 ea.		Are there Junior members	
10		Is there a separate Junior League	
5		Has each member been handed a NHPF donation brochure	
10		Are league results printed in the local paper	
5		Does the league have a copy of NHPA Constitution & By-laws	
10 ea.		Is there Community Outreach Involvement: Charity Tournament, Parade, etc.	
25		Host annual Open tournament	
10		Tournament results posted in local newspaper	
5		Is there Junior member mentor program	
10		Sanctioned Court Certificate	
10 ea.		Special Projects	
		Total Points Earned	

EXAMPLE REVIEW SHEET of CHARTER PROMOTION

Point Value	Date for Completion	Project Item	Points Earned
25		Charter Newsletter received by each member	
10		50% of membership participate in State Tournament	
15		New Member Packets provided to each new member	
5 ea.		# of Sanctioned Clubs	
15		Ongoing/active efforts to support NHPF	
10 ea.		Prompt charity events to benefit outside agencies or organizations	
10		Junior Promotion and Recruiting Program	
5		Scholarship Program	
10		Have a Junior Program Director	
10		Have a Media Contact Director	
10		Membership increased over previous year	
15		Public Hall of Fame display	
10		Junior Mentor Program	
10		Membership Awareness efforts	
5		Training seminars for judges	
5		Official shoe checking at tournaments	
10		Game related sales rep in state	
10		Membership list on a electronic database	
10		NatStats reporting is prompt	
		Total Points Earned	

EXAMPLE REVIEW SHEET FOR INDIVIDUAL MEMBER

Point Value	Date for Completion	Project Item	Points Earned
25		Tournament Director - over 100 entries	
15		Tournament Director - under 100 entries	
5 ea.		Recruited new NHPA member	
5		Article for state newsletter	
10		Article for Newsline	
10		Cash Contribution to NHPF	
25		Hold promotion presentation to a group	
25		Club Officer	
50		Charter Officer	
10		Charter Committee Member	
10 ea.		Special Project	
		Total Points Earned	

A JUNIOR PROMOTING JUNIORS

A Junior Profile on Noah Elich of Colorado

by Heidi Poppe

In a suburb of Denver, Colorado (Westminster to be exact), lives a young man by the name of Noah Elich. I have only just begun to tell you his story... and what a remarkable story it is. He is a sophomore at Ranum High School, who likes to skateboard, play the drums in the school jazz band and most of all, he loves to play and promote horseshoes. He's not your ordinary junior horseshoe pitcher, he's the Colorado Junior Promotions Director!

Noah began pitching horseshoes just four years ago on a league with his parents in Edgewater, Colorado. After several attempts with different styles of pitching, Noah settled on the flip and proudly pitches the Challenger horseshoes, a specialty made by Bob White of Erie, Pennsylvania. Noah took 3rd place at the 2000 World Tournament in Class E and 2nd place at the Colorado State Singles Tournament in the Championship class. When I asked him what his greatest achievements were he stated, "being the Colorado Junior Representative." Noah has gotten 16 juniors to become NHPA members and attend the Colorado State Tournament. Not only is that a great accomplishment in itself, he and others raised enough money through fundraising and raffles to purchase jackets for all the Colorado juniors! Each jacket will bear the junior logo

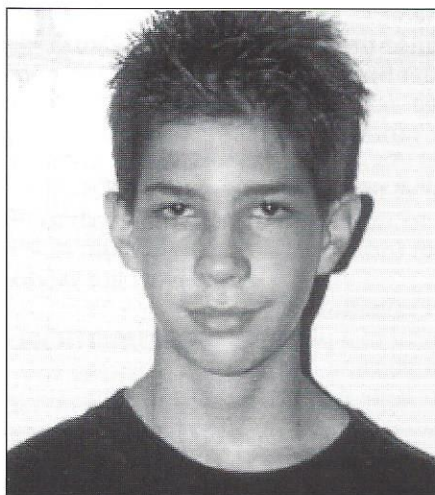

and the junior's name. He mentions Tony Gentry, Marty Zolman, Rich Jensen, Allen Baptist and his parents when he talks about the helpful hands of others who supported his efforts. Noah attributes fundraising to the success he has had in promoting junior pitchers. He believes that if you have a goal (his was getting more juniors involved and getting each one a jacket) that more people will help out and volunteer. Many pitchers and scorekeepers donated all their earnings after they heard the news of his great cause! Way to go!

So what else could possibly make Noah's story more fascinating? The Colorado Junior Newsletter that he

started. You got it—in Noah's spare time he creates a junior newsletter that includes stories about the juniors and games for them to play. He sends a copy of the Newsletter to all the Colorado juniors, the Colorado State Officers, executive committee, and the presidents of the nearby clubs. The Junior Newsletter started out as an English project, which included 8 hours of volunteer work. In the end, it turned out to be 145 points out of 100 and a job he still continues today!

Noah Elich should be an inspiration to all horseshoe pitchers! Never in my 14 years of pitching horseshoes nationally have I met anyone so enthusiastic to promote the game of horseshoes to juniors! So, I want to thank you Noah for doing your best to keep this great game alive! Good luck!

Promotion Ideas from Noah:

1. Each state should buy t-shirts for each junior pitcher and have a junior logo printed on it.
2. Junior Team World Tournament????
3. Fundraise! Fundraise! Fundraise!
4. More awards—i.e. junior player of the year

PROMOTIONS *Continued from page 15*

President, W.A. Banta, 618 Arch Street, Indianapolis

Sec. Treas., Paul S. Van Sickle, 32

Whittier Place, Indianapolis

Vice Pres., Ray Peckham, 2505

Chestnut Street, Fort Wayne

Vice Pres., William Everett, 2228 E.

Main Street, Lafayette

Vice Pres., James Stringer, No. Home

Ave., Columbus

Vice Pres., Charles Cowan,

Veedersburg

Vice Pres., Noah Malott, Mishawaka

Jimmy Risk won the state title for the years 1926 through 1930 in the meets held at the Indiana State Fair, but the years from 1930 to 1937 were years for horseshoe pitching in the state.

In 1937 the state joined the National Association and a state meet was held at

the courts of the Fall Creek Club in Indianapolis and the winner was Arlo Harris who averaged 74 percent. In 1938 the title went to James Cox of Perrysville. He did not lose a game in nine starts. Ernie Recht of Fort Wayne set a new state record for ringer average when he hit .755, but could only finish fourth. Ray Peckham was runner-up.

Jimmy Risk regained the state title in 1939 in the meet at Fort Wayne with Wayne Nelson of Muncie, runner-up.

Anderson is the scene of the annual A.A.U. National Junior Horseshoe Tournament.

MARYLAND—Maryland has never been a member of the National Association, but yearly tournaments have been with the following winners:

1929 Millard Peake, Bethesda

1930 Millard Paeke, Bethesda

1931 Joseph Merryman, Bladensburg

1932 Joseph Merryman, Bladensburg

1933 Lee Fleshman, Rogers Heights

1934 Lee Fleshman, Rogers Heights

1935 Temple R. Jarrell, Hyattsville

1936 Temple R. Jarrell, Hyattsville

1937 Lee Fleshman, Rogers Heights

1938 Lee Fleshman, Rogers Heights

1939 Lee Fleshman, Rogers Heights

Editor's Comment: This will be Bob's last column as National Promotion's Director. (See Dave's Court Report in the Sept/Oct Issue) We thank him for all his years of service in this capacity. He will concentrate more on the history of the game and will continue submitting articles for "The Horseshoe Trader."

THE HORSESHOE TRADER

The Innovation of William J. Martin

by Bob Dunn

To make any correlation to the efforts of William Martin to our sport, we have to understand that in the beginning of the interest in horseshoe pitching, the sport was more commonly called QUOITS. Quoits meant throwing a metal object at a stake. A quoit was and still is a round metal ring. But pitching a horseshoe at a stake was also referred to as quoits, sometimes as horseshoes. Never the less, today we can safely say when William Martin of Cleveland, Ohio began his quest to present a better quoit, he was really introducing a better horseshoe.

Martin's first patent was filed in January 1915. This was just after the formation of the Grand League of the American Horseshoe Pitchers' (Kansas City, Kansas) in 1914 and prior to The National League of Horseshoe and Quoit Pitchers in 1919. There was enough horseshoe pitching going on that Martin saw the need for a better horseshoe. Up to this point the shoes used in the game were that right off the horse or primitive models made by blacksmiths. His initial patent truly initiated the manufactured and precision designed pitching horseshoe.

The narrative for this patent is rather brief so it is being reprinted in total:

UNITED STATES PATENT OFFICE WILLIAM J. MARTIN, OF CLEVELAND, OHIO

QUOIT

1,138,234

Specification of Letters Patent

Patented May 4, 1915

Application filed January 18, 1915. Serial No. 2,858

To all whom it may concern:

Be it known that I, William J. Martin a citizen of the United States, residing at Cleveland, in the county of Cuyahoga and State of Ohio, have invented certain new and useful Improvements in Quoits, of which the following is a specification.

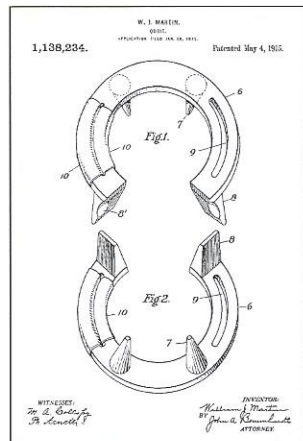

This invention relates to quoits and comprises a quoit in horseshoe form, modified as hereinafter pointed out to serve the intended purpose.

In the accompanying drawings, Figure 1 is a perspective view of the quoit showing the top and Fig. 2 showing the bottom or underside.

In the drawings, 6 indicates the

body of the quoit having a form or outline similar to that of a horseshoe, and provided on its underside of face with two front conical calks or points 7, and at the heel with wedge shaped calks 8. The outer corners of the latter are recessed or beveled as indicated at 8, to receive the index finger of the player when the quoit is pitched.

The side of the body of the quoit is slotted as indicated at 9, to receive a strip of chamois, leather or other soft material 10, which is wrapped around the bar and inserted through the slot to be held in place. The chamois, leather or similar soft material may be applied to either side of the quoit, according to whether the player is right or left handed, and its purpose is to prevent blistering or injury to the hand of the player.

The device is used in the usual manner and the calks serve the purpose of preventing sliding of the quoit after it strikes the ground.

What I claim as new is:

A quoit, the body of which is provided with a slot and a covering of flexible material extending around the body and through the slot.

In testimony whereof, I affix my signature in presence of two witnesses.

WILLIAM J. MARTIN

Witnesses: John A. Bommhardt

J. B. Davis

Just over a year after receiving his first patent, Martin received his second patent on August 1, 1916. The narrative in this application is considerable so the reprinting is prohibited, but it is the illustration that is the most interesting in any event. The roundish shape and make-up is so similar to other shoes found that can be identified as pre-1919. The shape of the heel calks and the peg style toe calks are represented again in the picture of his 1919 improved pitching style horseshoe. Martin redesigned his 1916 version to comply with the 1919 draft of the standards for the official horseshoe. Keeping peg style calks certainly kept an uniqueness to the other pitching shoes being designed during the era. But the lock-on innovation must not have been too popular with the pitchers as Martin also began manufacturing the Martin National Shoe with the tradition style toe calk.

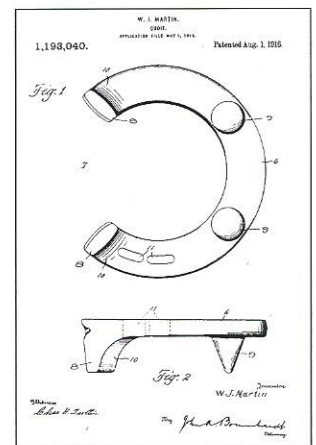

Ohio, National Standard and Lucky Ringer are given cred-

Continued on page 19

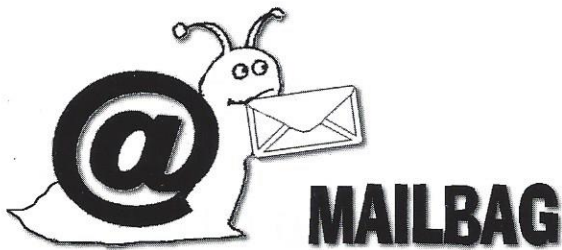

UNITED WE STAND IN HOPE

I received an email from a horseshoe pitcher with a letter attached that they had received from another horseshoe pitcher. How many of us are thinking the same thoughts but haven't taken the time to voice them?

Paula Summerlin, Editor

Hello,

I have been in shock since 9-11. I think most of America is in shock even to this day. The patriotism that we see all around is testimony to how deeply this has affected us all. We go along from day to day and live our lives and enjoy the freedom to do so and totally take that freedom for granted. We complain about everything and criticize our leaders for the bickering about who is right on every conceivable issue.

We question everything and argue with others that question us. We forget that there are places in this world where it is a sin to question the leaders or for women to even question their husband. No wonder they think we are immoral. We don't even think of those places and people because their ideas and principals are so different from ours and in our minds are so primitive that we think they are completely obsolete and even non-existent. I guess we know now that they do exist. They certainly got my attention.

It has been a long time since I reviewed how I felt about America in general. Most of my thoughts about America have been along the lines of being critical. I complain about taxes and politicians and how they spend those taxes and waste my money. Today I feel completely different about our country. I am no longer taking our great freedom and liberty for granted. God bless America has taken on a whole new meaning and importance to me.

I have had a tendency to pay attention only to my own little piece of America and I have taken the whole picture of America for granted. This event has forced me to open my eyes and see what a great country we have here in the USA. Now the taxes are not as painful as they were. The politicians are not as petty as they were. The arguments and constant questioning have risen from an annoyance to become a great symbol of our freedom. I don't think I will ever look at things the same again.

It is truly a shame that we need to be so severely shocked to appreciate what we have. It is the same as wishing that we had told a friend that we love them before they died. I am a very loving person in my heart but I am also private about my feelings so I never make it a point to tell people that I love them. I try to show people in my everyday life but that is not good enough. When someone dies we wonder if they knew how important and special they were to us we wonder if they knew we loved them and appreciated them.

I now realize a little better what is truly important to me. I am sending this mushy and patriotic note out to you and to several of my good friends to let you know that you are loved and appreciated and are important to me before some ter-

rorist takes away my ability to tell you.

Thank you for being my friend and making my little piece of America as special as it is.

GOD BLESS AMERICA

Dear Editor,

The letter from the Postal Service regarding a commemorative stamp was a thoughtful response to Charles Bunner. It was clear, concise, courteous and complete.

The Postal Service is in difficult time. E-mail is draining millions of dollars from Post Office receipts. Moreover, ever-increasing fuel costs have dramatically affected mail delivery expenses.

Consequently, the Post Office must issue stamps that are expected to be big sellers. Stamps that people will want to collect—as well as use. The Elvis Presley stamp for example, was a tremendous success. As is the current Statue of Liberty stamp. The Postal Service has in the works a baseball stadium stamp—8 different major league ballparks. Collectors and baseball fans (who isn't) will buy a ton.

What is the market for a horseshoe stamp? NHPA membership is less than thirteen thousand. Who else? Are millions of post office customers going to request the horseshoe stamp? I don't think so. But that doesn't suggest we shouldn't continue our quest. Let's deluge the Postal Service with letters.

Maybe the Postal Service spokesperson, Deborah Leifer, loves horseshoes too.

Ed Quigley

New Jersey Regional Director

September 17, 2001

Dear Paula,

A more descriptive name: Horseshoe Pitching NEWSLINE—and a new Editor. Congratulations!!!

Looking forward to the woman's touch.

Wishoe the Best,

Ed Quigley

New Jersey Regional Director

September 17, 2001

Hello All,

We have just returned from a visit with Earl's cancer doctor to learn the results of the tests and scans that were done last Monday. THE NEWS IS GOOD! We can all use some good news after the events of recent days.

Earl took his last chemo treatment on July 27th. There is no sign of any cancer at the current time. The blood tests are all good and scans and x-rays are all good. The spot on a kidney has not changed since January. They believe it is just a

Continued next page

KENOSHA HORSESHOE CLUB HOLDS ANNUAL BENEFIT TOURNAMENT FOR SPECIAL OLYMPICS

By Harry Nelson

The Kenosha Horseshoe Club held its Annual Benefit Horseshoe Tournament at Nash Park on Saturday, July 21st. This year it was decided to support the Special Olympics. Ten teams of doubles with an 85% team percentage limit played a round robin.

In addition to the entry fee, to raise even more money, pitchers went to businesses and other individuals asking them to sponsor them by paying either a specified amount per ringer or a set amount.

A short ceremony began at noon. Jim Ryan, a representative of Special Olympics, made a short speech and then introduced Kim White, the area director, who explained what Special Olympics is and what it does. All the pitchers in the tournament were introduced and given a Special Olympic towel. The tournament was then underway, with Jim Ryan pitching the first two shoes.

There were four world-class champions pitching in this benefit; Harry Nelson, 1996; Fred Decorah, 1997; Lloyd Johnson, 1999 and Hi Chaffin, 1999. Also pitching were Six Wisconsin State Walking Doubles Champions; Ray Billen, 1999; Dick Muhlenbeck, 2000; Jane Hartman, 2000; Denny Hartman, 2001; Scott Muhlenbeck, 2001 and Bill Hagen, 2001. All but one belong to the Kenosha Horseshoe Club.

What made this benefit unique and may possibly be the reason for its' success, was that there were horseshoe pitchers who did not pitch in the benefit sponsoring the ones who were. The name of the game for this particular tournament was ringers for the kids of Special Olympics.

The Kenosha Horseshoe Club is very proud of all the pitchers and workers that participated and made it possible to raise over \$1925.00 for the kids. The teams were very successful in their sponsorship efforts. Harry Nelson and Glenn Ellis pitched for \$4.17 per ringer, while Linda Johnson and Dan Birch pitched for \$3.28 per ringer, with the teams of Dick and Scott Muhlenbeck pitching for \$2.78 per ringer and

Fred Decorah and Debbie Marshall for \$1.07 per ringer.

Because the temperature was around the 100-degree mark, one pitcher had to drop out after four rounds and the last round was shortened to 20 shoes instead of 30 shoes. Three of our workers, Pat Nelson, Vera Johnson and Bonnie Hagen tried to help keep the pitchers cool by soaking towels in water for their necks. The heat played a major factor in the averages pitched by the pitchers. Not one pitcher pitched their average. But even with the extreme heat, the tournament was completed and everyone stayed after to hear the results and help to take care of things and clean up.

Lou Bensing from Florida and Bill Hagen from Salem, Wisconsin took First Place with eight wins and only one loss.

Results of Special Olympics Tournament

First Place	Lou Bensing	25.9%	8/1
	Bill Hagen	30.9%	
Second Place	Dick Muhlenbeck	45.0%	6.5/2.5
	Scott Muhlenbeck	20.0%	
Third Place	Linda Johnson	35.9%	5.5/3.5
	Dan Birch	26.8%	
Fourth Place	Lloyd Johnson	33.6%	5/4
	Ray Billen	24.1%	
Fifth Place	Everett Stewart	32.2%	5/4
	Dale Shamberg	22.2%	
Sixth Place	Fred Decorah	26.4%	5/4
	Debbie Marshall	27.7%	
Seventh Place	Hi Chaffin	36.8%	3/6
	Bob Power	20.0%	
Eighth Place	Glenn Bogenschneider	30.9%	3/6
	Don Peroutka	15.0%	
Ninth Place	Denny Hartman	29.0%	2.5/6.5
	Jane Hartman	22.7%	
Tenth Place	Harry Nelson	40.5%	1.5/7.5
	Glenn Ellis	14.0%	

MAILBAG *Cont. from page 18*

cyst and will not do anymore follow-up on it, as it was scanned in June and again last Monday. For the time being, Earl will be doing visits every 4 months with the colon cancer doctor and is still doing visits every 6 months with the prostate cancer doctor. We can handle that!

We thank you all for your prayers and the messages that have come our way over the last several months. The prayers have been answered and God has helped us through another difficult time. Just thought you would like to know.

Please continue to pray for our country, it's leaders, the rescue workers, our people in the military and the victims of the terrorists and their families. A nation that is united under God can and will prevail.

God bless all of you.
Vicki and Earl

HORSESHOE TRADER *Cont. from page 17*

MARTIN'S FAMOUS HORSE SHOES

Were pitched at the Mid-Western National Tournament, Lake Waukegan, Illinois, 1925, and St. Paul, Minnesota, 1926, with success.

Martin's Non-Skid Interlocking Horseshoe

The Shoe They See the Fair. The Marks on the Sole of the Shoe.

Some of the most successful pitchers in the world, who have won the "Martin Shoe" for pitched shoes in the last great tournament, in St. Paul, Minn., with 100% team percentage, all pitched for the same shoe. The tournament was held at the St. Paul Hotel, St. Paul, Minn., on July 1st, 1926.

Some of the most successful pitchers in the world, who have won the "Martin Shoe" for pitched shoes in the last great tournament, in St. Paul, Minn., with 100% team percentage, all pitched for the same shoe. The tournament was held at the St. Paul Hotel, St. Paul, Minn., on July 1st, 1926.

Some of the most successful pitchers in the world, who have won the "Martin Shoe" for pitched shoes in the last great tournament, in St. Paul, Minn., with 100% team percentage, all pitched for the same shoe. The tournament was held at the St. Paul Hotel, St. Paul, Minn., on July 1st, 1926.

Martin's New Model C & D Shoes

Wide Last

W. J. Martin
111 E. South Street
Chicago, Ill.

THE NEW MODEL C & D SHOES
No. 1000
No. 1001
No. 1002
No. 1003
No. 1004
No. 1005
No. 1006
No. 1007
No. 1008
No. 1009
No. 1010

All orders sent by registered mail. Certified Check or Money Order.

it for being the first commercial-ly manufactured pitching shoes. This is the case because there is no evidence that Martin was in the market at the same time or of comparable volume in selling shoes. The earliest advertisement found for Martin shoes is from a 1928 *Horseshoe World* magazine. This ad states that the shoes were pitched in the 1925 and 1926 World Tournaments.

There is a definite pattern here though, to say that William Martin is the first to design the manufactured pitching shoe.

2002 World Tournament Report

RED DEER, ALBERTA, CANADA

Loucks Visits 2002 WHT Site

NHPA President, Dave Loucks and his wife, Cathie were in Red Deer September 23rd, 24th and 25th to visit the site of the 2002 World Horseshoe Tournament in Red Deer, Alberta, Canada. They were met on Sunday evening by the 2002 WHT Chairman, Bill Gibson and his wife Merla and taken on a brief tour of the city. Monday morning, Ken Yoxall, tournament facility Chair, led Dave on a familiarization tour of the Westerner Park tournament site. At a noon press conference held at the host hotel, The Red Deer Lodge, the Mayor of Red Deer, Gail Surkan, welcomed Dave and Cathie, presented Dave with a red Stetson and assured him that all would be ready for the World Tournament including Canadian western hospitality.



Dave gave the tournament facility and the City of Red Deer a ringing endorsement, saying the facilities were among the best he had seen in years. "It offers so much that I'm having a little trouble deciding what to take and what to let go" he said. The two pavilions at the Westerner are air-conditioned and have room for 58 courts with adequate spectators seating. "You are presenting us with an ideal community atmosphere. Red Deer is just about the right size for us." Driving around the city, he noted the pleasant setting and easy access to everything. "We're going to enjoy ourselves here."

Dave also noted that this is the second time the World Championship Tournament is being held in Canada, the first time being in Kitchener, Ontario in 1997.

Following a dinner with several 2002 WHT Committee members on Monday evening, Dave and Cathie left Red Deer the next day expressing confidence and appreciation to the local committee in anticipation of the tournament events in 2002.

Tournament Update

The **tournament web site** has the latest information. It can be found at www.2002WHT.ab.ca as well as a link through the NHPA website at www.horseshoepitching.com

OUR HOST HOTELS are: (if calling mention 2002WHT)

Red Deer Lodge, \$89.00 Can.

4311 49th Ave., Red Deer, AB, Can. T4N 5Y7
1-800-661-1657, Fax 1-403-341-3220

Travelodge Red Deer, \$89.00 Can.

2807 50th Ave., Red Deer, AB, Can. T4N 1H6
1-888-383-2344, Fax 1-403-346-1075

Other hotel accommodation information is available via Red Deer Visitor and Convention Bureau:

1-800-215-8946, www.tourismreddeer.net

E-mail: tourisminfo@reddeer.net

(over 1400 hotel rooms are available in Red Deer with 600 reserved until June 1st, 2002)

RV PARKING AND CAMPING:

On site—100 on-site RV parking, most with 15 amp power, sewage disposal, potable water and some shower availability. Rate and reservation information available after December 1st.

In the City—Lions Campground, 50 sites, PWS, Between May 1st and Sept. 30th
phone: 1-403-342-8183 (mention 2002WHT)

At Pine Lake—(30 minutes south east of Red Deer)

- **Leisure Campgrounds** 1-403-886-4705

Fax: 1-403-886-2045 (360 sites, PWS)

- **Green Acres** 1-888-999-4833,

greenacr@telusplanet.net

Fax. 1-403-886-2250 (400 sites, PWS)

- **Whispering Pines G & CC Resort**

1-403-886-5111, www.whisperingpines.ab.ca

Fax. 1-403-886-4503 (113 sites PWS)

AIRPORT TRAVEL

From Calgary International Airport, it is a 90 minute drive north to Red Deer. From Edmonton International Airport it is a 90 minute drive south to Red Deer. Both airports are served by several US airlines as well as Air Canada and West Jet. Car rental is available in both places but should be reserved well ahead of your arrival.

Travelers from the eastern coast might consider driving to Hamilton, Ontario (close to Buffalo) and flying by West Jet to Calgary. West Jet is a Canadian discount airline.

Border Crossing: Due to recent events and changing conditions, all visitors to Canada, should be sure to check on documents needed and border crossing information well in advance of your planned travel time.

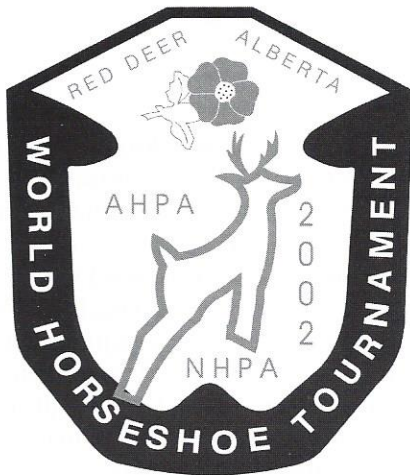

You are invited to enjoy our
Western Hospitality
at the
2002 World Horseshoe Tournament
Red Deer, Alberta, Canada

July 29–August 10, 2002

<http://www.2002wbt.ab.ca>

Include in your vacation planning:

*The Calgary Stampede (July 5-14),
Red Deer Westerner Days (July 17-21),
Banff, Canadian Rockies,
Lake Louise, Jasper and
The West Edmonton Mall*

Red Deer Facts

Population: 68,300

Average July temperature: 60°F

(Night 50°F: Day 75°F)

Motto: Education, Industry, Progress

Red Deer is 7.3 hours driving hours
north from Great Falls, Montana

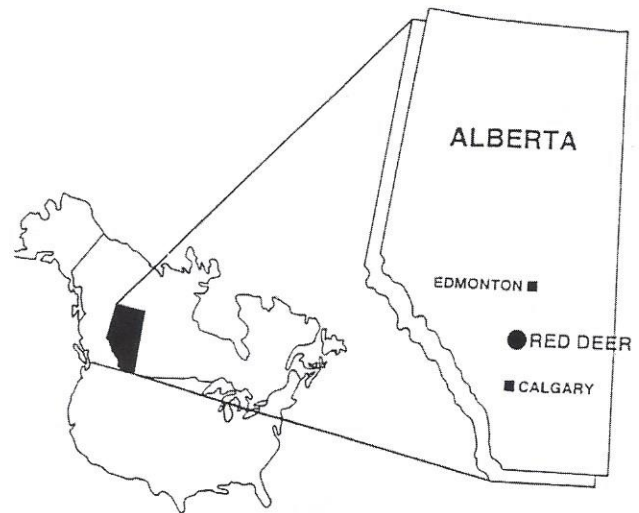

Visit Awesome Alberta This Year

As You Pitch And Play In Red Deer

Friends of Horseshoes

With the economic downturn, fundraising is an added challenge. Your help would be appreciated to stage the
2002 World Horseshoe Tournament

Friends donating \$50.00 or more will be acknowledged in
the Tournament Program, the Events Board on site and in the post tournament newspaper ad.

Donation Cheques, made out to 2002WHT, should be sent to
Bill Gibson, 305-4614-47A Ave., Red Deer, AB, T4N 3R4

To place an ad in the program please contact
Keith Rideout 1-800-533-5562

BROOKLYN PARK HORSESHOE CLUB OF MINNESOTA CONCLUDES SEASON #21

By Bob Dunn

Our 2001 Awards Banquet was held September 14th, with a beautiful sit-down dinner of sirloin steak, ribs or chicken. Approximately 40 members and significant others attended.

The championship team was from Tuesday and included: Colin Gisslen, Harvey Arola, Jackie Schodde and Andy Gitzen. The championship was won in a play-off over the champs from Monday night. The runner-up team consisted of: Jim Beyer, Arnie Johnson, Les Lenert and Jessica Dunn. Tuesday also won the battle for 3rd place: Mary Matuke, Marlene Knudtson, Hardy Anderson and Peter Moberg. The 4th place team was: Bob Knudtson, Paula Mismash, Ray Hardy, Bev Skinner and Gary Fisher.

High average honor went to Mary Matuke with 51.59%, who also shared high game honors with Floyd Knudtson at 68.0%. Jerry LaBrosse, runner-up in the Men's Championship Class at the state tournament held in Forest Lake, had the top average of 55.03% in the Thursday no-handicap league and was the league champion with a 56-6 record. Ray Volkers had the high game on Thursday at 77.5%.

The Class Tournament winners were: Class A—Cliff Presler 3-2, 55%; Class B—Paula Mismash 4-1, 37.5%; Class C—Tim Knudtson 5-0, 46.0%; Class D—Ben LaCouriere 4-1, 34.4%; Class E—Andy Gitzen 5-1, 18.5%; Class F—Sandy Bueckers 4-2, 7.5%. Thursday's class winners were: Class A—

Bill Larson, Class B—Cliff Presler.

Most Improved honors went to: Arnie Johnson +4.63 and Jerry LaBrosse +7.9%. High Game Over Average awards went to: Floyd Knudtson +33.40, Ralph Marcks +25.75% and Ray Volkers +28.24%.

Bob Knutson received the best win/loss award with a 36-10 record. Bob also was the recipient of the MGSHPA Frank Stinson Memorial Award as the top tournament pitcher in the MGSHPA Pitcher of the Year Program. Marlene Knutson was named MGSHPA Scorekeeper of the Year for 2001. Both of these awards were presented at the Awards Banquet during the state tournament. Bob also won his class at the 2001 World Tournament in Hibbing.

Sportsman Award patches were presented to Ben LaCouriere and Roger Tripp. Paula Mismash, Rob Hagman and Ray Volkers received Rookie of the Year Patches.

The banquet concluded with the presentation of the infamous Unfortunate Pitcher of the Year. Following the 15-minute roast of several unfortunate pitchers, the traveling award was presented to Sandy Bueckers by last year's recipient Pete Moberg. Sandy is the first woman to receive the award. During the presentation, Moberg shared pictures of his world tour with the trophy. The pictures included famous scenes including the Eiffel Tower and the Leaning Tower of Pizza.

SIX PAC



HORSESHOES®

Tournament Quality

Pitched in A-Z Classes
Discount on 6 Pair or more
ONE YEAR GUARANTEE

Order Direct or
from your NHPA Representative
SIX PAC HORSESHOES
4811 Tishomingo Road
Hillsboro, MO 63050
Attn: Harvey E. Wobbe
(636) 942-3544

Stay Informed Keep Subscription Current

Don't let your "Horseshoe Pitching Newsline" subscription lapse. Check the expiration date on the mailing label. If it is 12/01/01, this is your last issue and you should mail a renewal now.

NHPA "Horseshoe Pitching Newsline" Subscription Renewal Form

Name _____

Address _____

City/State/Zip _____

Phone _____

New Subscriber Renewal

Subscription price for one, two, three years is
\$12.00, \$22.00, \$30.00 for standard mailing in the U.S.
Add \$8.00/yr. for First Class.

Canada is \$20.00, \$38.00 or \$54.00

Make checks payable and mail with form to:
NHPA Secretary/Treasurer
3085 76th Street
Franksville, WI 53126

If you have missed an issue,
limited copies of most back issues are available for \$3.00.
Send all back copy requests with payment to *Horseshoe Pitching NEWSLINE* Editor,
P.O. Box 536, Webberville, MI 48892-0536

THE TRI-COUNTY HORSESHOE PITCHER CLUB

Submitted by Lu Cave, President and Rosie Leyk, Secretary/Treasurer

The Tri-County Horseshoe Pitchers Club is located at the Leyk's 3 and 1 Courts. It has 12-lighted courts and is located in the countryside of Sauk Rapids, Minnesota. The club was formed in 1977 with nearly 200 members. Back in those days most everyone was eager to try the sport. We had three nights of pitching, with five leagues participating in the club. In the last five years we have had a mixed league with 35 dedicated pitchers.

Our first president, Don Slomkowski, who is now retired, helped keep the leagues full. Dennis Carlson, another of our presidents, designed a computer program to track pitching information. He later went on to become our state statistician. In the early 80's, during the month of March, our members held pitching demonstrations and small tournaments at the Crossroads Mall in St. Cloud, Minnesota. We invited pitchers from all over Minnesota and Wisconsin. We had a lot of fun pitching there and never broke any mall windows with those lucky horseshoes.

Through the years, our club has had two National Lady Champions. Our first World Champion was Phyllis Negaard, who won the title a total of five times. Then followed her sister, Bev Nathe, who captured two titles. These two pitchers also share our state titles. Phyllis has been State Champion fourteen times and Bev has held that title nine times. Rosie Leyk, is also one of our top pitchers. She qualified for the Women's World Championship Class in 1981 in Genola and again in 1987 in Eau Claire. Lu Cave, another one of our top

pitchers, has qualified for the Women's World Championship Class three times. She qualified in Eau Claire, Columbus, and Spearfish.

Some of the best pitchers in our state still pitch in our club. One year in particular, we had eight high percentage ladies out of the top twelve. In the same year, we had five pitchers entered in the State Tournament Championship Class of six. Our club has held 25 annual open tournaments. We also hosted the Minnesota State Tournament in 1980, which was held at the Preimesberger Arena in Genola, Minnesota. That year was possibly one of the largest tournaments with 302 men, 76 ladies and 54 juniors entered. We also had the opportunity to host our state's Star of the North Games in 1997.

Our club organized junior leagues from 1980 through 1982, with some 22 junior pitchers participating. In those years we had bus loads of school children come to our courts for summer class. Youngsters from the St. Cloud Children's Home were also bussed to the courts for on-hand pitching. Some of the club members who were free on certain days would help instruct these youngsters. We have had junior state champions. Corine Cave was our Junior Girl's State Champion in 1984 and her sister Christy won the title in 1989. Corine also won the Class B Championship at the World Tournament in Genola in 1981.

We have four families who through the years have contributed to our club. They are the Cave family with Les, Lu, and children; the Notch family with Bev, Phyllis, their mother and sisters and the Vanderweyst family of Myron, Linda, Peter and Charles. The Vanderweyst family has co-hosted our annual Tri-County tournament for years. Richard Leyk has done a terrific job of taking care of the courts for the enjoyment of all the pitchers.

Many wonderful people have come and gone in the past 25 years and every one of them has fond memories of pitching at the courts.

HORSESHOES 101



- *How to pitch*
 - *How to promote*
 - *Events*
 - *World Records*
 - *Current Promotional Efforts*
- Dedicated to the Game We Love*

Please send check to
- Don Titcomb - 9060
Auburn-Folsom Rd. #4
Granite Bay, CA 95746
\$10.00 includes mailing

BY DON TITCOMB

Editor's Note:

The July/August 2001 Issue of *Newsline* (The Used Key, page 28) incorrectly reported Ted Allen's year of death as 1993. To correct the record, Ted Allen was born in 1908 and passed away on January 24, 1990. Thank you to Glenn Blackmore for bringing this to my attention.

I was pleasantly surprised at our 2001 National Convention in Hibbing, Minnesota when Casey Sluys asked the question as to how many people were online and then asked how many viewed the NHPA Website & Publicity page at least once a week. More than 75% of the people in attendance raised their hand.

The number of new computer owners and of people online continues to grow at an incredible rate. What this means is more traffic on the Internet and also to the NHPA website. We are now averaging about 550 visitors per day on the website and not all of those visitors are NHPA members. Many are new visitors that find us while surfing or by using search engines. This makes your Charter Websites even more important. Through your Charter Websites the new visitors, along with our regular visitors, can find out what's happening in horseshoes in their local area, such as clubs/leagues, tournament, contact persons, schedules, tournament results, and links to many of the features on the NHPA website. Wow!! Would you believe that all but five of our Charters have a website.

What's New? We now have an online donation link for the NHPF on the NHPA Website's front page. Click on the banner and it will take you to a secured website, Active.com, where you will find a form that will walk you through the steps needed to send your donation. We are providing this online donation form to make contributing easy for you. This server maintains service charges, which amount to 50-cents plus 6.5% per transaction; a small amount when compared to other e-trade software. We encourage all Charter Webmasters to add this link to their charter websites.

Have you visited the World Champions and World Class Champions pictures yet? If not, click on the banner at the top of the page that says "2001 World Champions." This will take you to the 2001 World Report page where you will find the link to our Champions and other links to just about everything else that happened at the 2001 World Tournament in Hibbing. While you are in there, check

out the link that says "Game of the Day." Here you can view the score sheets of some of the more interesting games that took place at the 2001 World Tournament, inning by inning. We hope you enjoy this new feature; we plan to bring you even more of them from next year's World Tournament in Red Deer.

While you are visiting the NHPA

website, don't miss reading Betty's World 2001, perspective of a non-pitcher. Then you can visit the Publicity Page, sign our guestbook, visit or leave a message on the message post, fill out your profile on the Pitchers Profile or just surf from link to link to view thousands of pages of horseshoe pitching information.

Wishing you cool surfing.



SIX PAC
HORSESHOES®

TOURNAMENT QUALITY

N.H.P.A. APPROVED

4811 Tishomingo Rd.
Hillsboro MO 63050

(636) 942-3544



Six Pac Sure Peg Six Pac Sure Point Six Pac Sure Pitch

Horseshoe pitching is a game the whole family and all ages can enjoy for fun and exercise and championship play. The SIX PAC is cast of Ductile iron and annealed (softened) to make the shoe absorbent tough when ringing the peg.

FEATURES:

- Blades thicker, wider (more control) • Position marker (finger notch) • Hooks and Points (hardened to retain shape) • Guarantee (one year against breakage) • Annealed (for softness) • Special Coated Finish

One Pair - \$42.50 ea. • Six Pairs or more - \$36.50 ea.

		ORDER FORM
<p>Six Pac Sure Peg Weights</p> <p> No. of Pairs _____ <input type="checkbox"/> L x \$42.50= _____ <input type="checkbox"/> M (at 6 pairs or more) _____ <input type="checkbox"/> H x \$36.50= _____</p>		Name _____
<p>Six Pac Sure Point Weights</p> <p> No. of Pairs _____ <input type="checkbox"/> L x \$42.50= _____ <input type="checkbox"/> M (at 6 pairs or more) _____ <input type="checkbox"/> H x \$36.50= _____</p>		Shipping Address _____
<p>Six Pac Sure Pitch Weights</p> <p> No. of Pairs _____ <input type="checkbox"/> L x \$42.50= _____ <input type="checkbox"/> M (at 6 pairs or more) _____ <input type="checkbox"/> H x \$36.50= _____</p>		Phone: Residence () _____
<p>Continental US only _____ Missouri Residents add sales tax _____ Shipping & Handling _____ (Single Pair only \$5.00 Charge) _____ GRAND TOTAL _____</p>		<p>Office () _____</p> <p>SIX PAC Guarantee: One (1) year from purchase date, not from replacement date. Both shoes must be returned in original carton showing date of purchase, weight and type of horseshoe. Return to manufacturer only. Include \$5.00 check or money order for shipping and handling costs.</p> <p>Thank you for your order and good horseshoe pitching. Order Direct or from your N.H.P.A. Representative Send to: SIX PAC HORSESHOES 4811 Tishomingo Road, Hillsboro, MO 63050 Attn: Harvey E. Wobbe (636) 942-3544</p>

2001 CANADIAN CHAMPIONSHIPS

Wellesley, Ontario • August 15-18, 2001

OUR CANADIAN CHAMPIONS:

Men—Adam Ellis (Ontario)

Women—Sylvianne Moisan (Quebec)

Junior Boys—Drew Becker (Ontario)

Junior Girls—Christine Sparks (B.C.)

Senior Men 40 Feet—Vern Tyacke (Saskatchewan)

Senior Men 30 Feet—Don Griffith (Alberta)

Senior Ladies—Heather Morrison (Ontario)

Junior Boys A

Drew Becker Ont. 15-0 62.26

Junior Boys B

Tyler McLean Alta. 11-5 23.75

Junior Girls A

Christine Sparks B.C. 15-1 36.40

Junior Girls B

Kelly Mallette Ont. 13-3 41.87

Mens A

Adam Ellis Ont. 15-2 70.97

Tom Gallina Ont. 13-6 64.45

Ronald Parisien Ont. 11-5 68.13

Roy Nahls Ont. 11-5 65.94

Steve Hohl Ont. 10-5 62.18

Edward Neeb Ont. 10-5 60.17

Howard Weitzel Sask. 9-6 66.75

Alvin Nanninga Alta. 9-6 57.46

Andre LeClerc Que. 8-7 57.12

Clyde Smoke Ont. 7-8 58.35

Hank Rodgers Que. 7-8 54.21

Gordon Butts B.C. 6-9 54.11

Rosaire Brunelle Que. 5-10 46.78

Louis Prud'homme Que. 2-13 48.94

Terry Steinke Alta. 1-14 39.96

Todd Irving Ont. 0-15 32.54

Mens Open Class B

Kenneth Drury Ont. 19-3 46.23

Mens Open Class C

Keith Lindsay Ont. 13-2 46.23

Mens Open Class D

John Snell Ont. 14-2 40.27

Mens Open Class E

George Barton N.B. 14-2 33.01

Mens Open Class F

Gary Puddicombe Ont. 17-1 35.00

Ladies Open Class A

Sylvianne Moisan Que. 20-2 79.90

Angeline Moisan Que. 17-6 68.42

Sheila McGrath Ont. 15-6 65.00

Lucille Leis Ont. 14-6 67.97

Elda Hastings Ont. 14-6 65.76

Myrna Kissick Alta. 11-9 60.24

Cecile Ross Ont. 8-1 55.08

Elyse Brunelle B.C. 7-13 58.57

Jan Ross Ont. 4-16 43.16

Tammy Norvila Sask. 2-18 43.47

Laura Nahls Ont. 1-19 32.78

Ladies Open Class B

Joanne Nanninga Alta. 18-4 53.59

Ladies Open Class C

Lia Snell Ont. 14-1 47.52

Ladies Open Class D

Cathy Rice Ont. 12-3 38.14

Ladies Open Class E

Pat Martin Ont. 15-3 19.58

Sr. Men 40 Feet A

Bern Tyacke Sask. 11-1 51.95

Larry Markle Ont. 8-4 54.31

Lloyd Fountain Ont. 5-7 48.28

Al Ross Sask. 4-8 44.25

Tom Corner Ont. 2-10 38.90

Sr. Men 40 Feet B

John Jansen Ont. 9-3 33.27

Sr. Men 30 Feet A

Don Griffith Alta. 8-5 59.42

Wilf Gregory B.C. 7-6 60.26

Ed Claussen Alta. 4-8 55.67

Sr. Men 30 Feet B

Edwin Danby Ont. 15-3 40.09

2001 RINGER CLASSIC

Greenville, Ohio • June 30-July 2, 2001

In a game pitched on July 2nd at the Ringer Classic between Joan Elmore from Tennessee and Sylvianne Moisan from Quebec, Canada, Joan pitched 52 consecutive ringers. The two pitched 13 consecutive four-dead.

Joan beat Sylvianne 45/31 to tie for first place, pitching 206 shoes. In the playoff, Sylvianne beat Joan 42/15 in 74 shoes. They were tied 25/25 at 60 shoes.

RESULTS OF THE 2001 RINGER CLASSIC

Mens A

Alan Francis OH 11-0 81.08%

Shannon Foster TN 10-1 78.04%

Jim Walters OH 8-3 77.18%

Tony Hankins KY 7-4 70.89%

Walter Ray Williams, Jr. FL 6-5 71.25%

Bob Hayes NY 6-5 68.79%

Matt Guy KY 5-6 69.50%

Stan Leis ONT 4-7 67.62%

John Walters OH 3-8 64.54%

Gary Roberts OH 3-8 64.17%

Mark Seibold IN 2-9 67.36%

Virg Rife OH 1-10 62.20%

Women's A

Sylvianne Moisan QUE 11-1 83.03%

Joan Elmore TN 10-2 81.04%

Judy Curtiss MI 8-3 78.37%

Sue Snyder KY 8-3 76.09%

Amy Francis OH 7-4 77.93%

Ruth Rife OH 6-5 69.59%

Brenda Tawney WV 5-6 68.77%

Lucille Leis ONT 3-8 67.78%

Angeline Moisan QUE 3-8 66.57%

Donna Dodson OH 3-8 63.11%

Becky Kemper KY 2-9 68.67%

Renee Cowan VA 1-10 58.45%

Elder's A

Bob Logan IN 5-0 80.81%

Bill Treisch OH 4-1 58.90%

James E. Smith OH 3-2 50.94%

Jim Hill OH 2-3 46.61%

Melvin Bair OH 1-4 39.38%

Don Carson OH 0-5 37.84%

Junior's A

Josh Brooks OH 5-0 63.10%

David Cowan, Jr. VA 4-1 53.45%

Charlene Hix VA 3-2 30.77%

Jason Fisher OH 2-3 29.32%

Carl Baer OH 1-4 18.22%

Rebecca Moore OH 0-5 19.92%

Mens B John Brown OH 10-1 68.37%

Mens C Roy Dugger OH 9-2 56.95%

Mens D Phil Hummel OH 6-0 58.63%

Mens E Delbert Fourman OH 6-1 51.71%

Mens F Ted Paver IN 7-0 52.26%

Mens G Sonny George OH 7-0 43.49%

Mens H Dave Johnson, Jr. OH 7-0 44.54%

Mens I Dave Brown OH 7-0 47.12%

Mens J Tom Winland OH 5-2 40.66%

Mens K Jim Hyatt OH 5-1 38.26%

Mens L Wilfred Kahrig OH 7-0 37.65%

Mens M Kenneth Smith, Sr. OH 6-1 32.81%

Mens N Jerry Fisher OH 6-1 26.59%

Mens O Gene Cathcart OH 7-0 22.85%

Mens P Gene Pettit OH 6-1 26.73%

Mens Q Robin Schwegert OH 4-0 12.08%

Women's B Jennifer Walters OH 7-0 62.17%

Women's C Stacy Sanders OH 6-1 54.70%

Women's D Kim Combs OH 7-0 38.46%

Women's E Sonya McDowell VA 4-1 33.61%

Elder's B Zack Campbell OH 6-0 42.54%

Junior's B Rebecca Sellers OH 5-0 13.51%

STATE/PROVINCIAL TOURNAMENT RESULTS

Missing State results that reach the Newslite editor by December 1 in the below format will be printed in the January/February issue, the last for reporting 2001 State Tournament results.

ALABAMA

Montgomery September 13, 2001		
Mens Championship	W-L	%
Jerome McCarty	6-1	56.6
Randal Light	5-2	50.7
Jackie Gary	4-3	47.0
Bill Coggin	4-3	46.4
James Conaway	3-4	46.7
Jim Harris	3-4	44.7
Wendell McGhar	2-5	45.0
Kendall McGhar	1-6	42.5
Mens B Donnie Chumley	5-0	48.7
Mens C Phil Brag	4-1	31.8
Mens D Mark McGhar	7-0	31.5
Mens E Mark Stevens	5-1	10.6
Elder Mens Champion		
Ottie Reno	4-0	50.7
Womens Championship		
Teresa Huff	2-2	21.5
Lori Goss	1-3	10.0
Jr Boys Championship		
Kenneth Hathcock	3-1	40.7
Mickey Fuller	1-3	12.2

ALBERTA

Calgary June 30, 2001		
Men Class A	W-L	%
Alvin Nanninga	10-2	64.50
Casey Vander Linden	9-3	61.67
Lyle Olmstead	3-9	52.00
Ross Stevenson	2-10	52.93
Men B George Fryngpan	8-2	45.25
Men C Ray Madu	9-2	39.77
Men D Doug Bonner	9-3	26.04
Elders Class A		
Ed Claussen	10-4	56.99
Don Griffith	8-5	59.31
Joe Duer	8-5	59.24
Len Scheibner	6-6	54.92
Cecil Nordvall	6-6	53.06
Murry Wilde	4-8	50.33
Bob Gray	2-10	46.82
Elder B Henry Dewald	8-2	49.00
Elder C Ernie Domshy	8-2	43.50
Elder D George Marquardt	9-2	30.00
Women Class A		
Myrna Kissick	7-4	60.07
Ina Fryngpan	6-5	56.15
Shirley Kooy	3-7	52.14
Wm B Joanne Nanninga	9-1	56.50
Wm C Eve Vander Linden	7-3	37.75
Wm D Betty Crerar	6-4	30.75
Wm E Anita Isaacs	9-3	22.50
Junior Boys Class A		
Tyler Mclean	6-6	21.87

ARIZONA

April 7-8, 2001		
Mens Championship	W-L	%
Gary Minnick, Sr.	6-0-0	64.63
Mike Amarillas	3-3-0	43.61
Frank Farley	0-6-0	40.00
Mens B Dale Boss	5-0-0	49.00
Mens C Tom Tabat	4-1-0	47.00
Mens D Dennis Bret	4-1-0	37.00
Mens E John Botha	4-1-0	33.50
Mens F Jim Fuller	6-1-1	30.32
Mens G Eddie Alldredge	7-1-0	20.31
Mens Elders Championship		
Bob Finck	5-0-0	57.42
Ken Brandt	4-1-0	43.79
Don Livingston	3-2-0	36.55
Ivan Griffith	1-4-0	33.06

Jim Cyrus	0-5-0	31.02
Mens Elders B		
Dick Lowrey	4-1-0	31.00
Women's Champion		
Ruthie Barrett	5-0-0	56.95
Brenda Beck	4-1-0	50.41
Carol Hoppe	3-2-0	47.67
Lorena Swann	2-3-0	34.01
Cheri Smith	1-4-0	37.31
Barbara Fuller	0-5-0	37.03
Wm B Ann Hardin	4-0-0	42.00
Wm C Nellie Anders	5-0-0	20.00

BRITISH COLUMBIA

Quesnel September 1 & 2, 2001		
Sep 1-4, 2000	Sanc. #23-00-022	
Mens Class A	W-L	%
Walter Kinakin	14-0	63.02
Lloyd Reyklin	9-5	47.95
Gordon Butts	8-6	49.84
Jerry Melissa	8-6	48.70
Jim Ball	8-6	47.17
Dave Arnold	4-10	41.13
Munj Manhas	3-11	46.02
Shane Greenside	2-12	43.96
Men B Bob Holler	10-1	42.55
Men C Larry Haner	9-3	34.71
Men D Lloyd Osborne	9-2	29.37
Men E Phil Erickson	8-2	24.43
Men F Robert Campbell	11-1	10.47
Elders 30 Feet Class A		
Fred Bodaly	8-2	64.44
Wilf Gregory	8-3	62.90
Murray Rayner	7-3	61.02
Lloyd Beggs	5-4	57.50
Oscar Hoyseth	5-4	55.60
John Collin	5-4	51.74
Ernie Connolly	3-6	53.14
Lloyd Milton	2-7	52.90
Gordon Snyder	2-7	50.23
Bill Whitnack	2-7	44.05
Elders 30 Ft B		
John Thornton	10-0	50.19
Elders 30 Ft C		
Garry Rayner	8-2	33.68
Elders 30 Ft D		
Bob Kennedy	10-2	32.93
Women Class A		
Elyse Brunelle	10-2	62.00
Brenda Arnold	7-5	49.31
Carol Ormiston	6-6	54.31
Leone Curtis	1-11	42.41
Wm B Bonnie Herrett	12-3	44.79
Wm C Shirley Vaugeois	8-2	36.85
Wm D Cheryl Brietkopf	10-0	30.32
Wm E Cheryl Cliche	9-3	25.50
Wm F Sylvianne Morgan	9-1	18.70
Junior Boys Class A		
Chris Aldridge	9-4	44.12
Buddy Dydra	8-5	39.49
Kyle Ford	7-5	34.79
David Harris	0-12	18.91
Junior Girls Class A		
Christine Sparks	7-5	33.91
Jr Boys B Zane Tousignant	11-1	30.73
Jr Girls B Katrina Breuer	9-3	27.94

CALIFORNIA

September 1, 2 & 3, 2001		
Mens Championship	W-L	%
Nathan Williams	11/0	69.5
Jesse Gonzales	9/2	60.4

John Sylvester	8/3	60.1
Earl Rapp	7/4	56.2
Chuck Seal	7/4	56.2
Paul Hopkins	6/5	55.3
Jonathan Williams	5/6	54.2
Ed Cortez	5/6	48.4
Dustin Hall	4/7	47.2
Bob Birge	2/9	45.6
Sam Boone	1/10	48.4
Andy Loobey	1/10	47.4
Mens A Mel Long, Jr.	9/2	54.5
Mens B Bill McBride	10/1	45.2
Mens C Frank Rodriguez	9/1	40.0
Mens D Glenn Rippetoe	9/2	44.0
Mens E John Stockstill	10/0	35.2
Mens F Gary Keiser	10/2	38.1
Mens G Steve McGrath	11/0	34.6
Mens H Mauri Hautaniemi	8/2	27.2
Mens I Hugh Cloutier	10/1	23.1
Mens J Rockey Gross	9/2	33.6
Mens K Dave Minton	9/1	17.0
Mens L Richard Gummart	9/1	14.2
Elders Championship		
Leldon Day	8/1	68.1
Victor Ford	7/2	60.6
Flash Mathenia	6/3	60.6
Bernard Merchen	6/3	60.0
Royce Keiser	6/3	56.3
Jim Gibbons	4/5	54.9
Pat Murtha	4/5	54.8
Don Titcomb	3/6	55.5
Cecil Miller	0/9	48.3
Elders A Ed Goedert	8/2	56.1
Elders B Andy Sauer	9/1	39.7
Elders C Nelson Diehl	9/2	47.7
Elders D Earl Smith	0/1	26.2
Womens Championship		
Sharon Paddock	8/1	70.3
Diane Silva	7/2	65.4
Vina Bowen	5/3	60.9
Gail Sluys	5/3	57.0
Connie Pannell	4/4	59.7
Teddy Guillotte	3/5	50.4
Linda Hoelscher	2/6	50.8
Frances Lopez	2/6	47.6
Elaine Butcher	1/7	37.7
Wm A Jenny Hoy	10/1	46.5
Wm B Mary Keiser	9/0	45.5
Junior Boys Championship		
Keith Boone	10/0	56.1
David Boone	5/5	29.1
Mark McGrath	5/5	32.5
Peter Fournier	0/10	4.5
Jr Boys A Arik Horton	6/0	15.8
Junior Girls Championship		
Amy Horton	7/3	40.3
Codie Anderson	3/7	27.8

CONNECTICUT

New Haven September 15-16, 2001		
Mens Championship	W-L	%
Norm Rioux	7-0	67.9
Bill Navratil	5-2	59.7
Bill Tompkins	5-2	58.0
Pete Schermerhorn	5-2	53.5
Don Maine	3-4	50.6
Cliff Costello	2-5	40.7
Mens B Chris Cristensen	6-1	59.3
Mens C Moe Brochu	6-1	48.3
Mens D Skip Gerber	6-1	46.0
Mens E Al Alba	6-1	42.9
Mens F Bob Murray	6-1	38.6

Mens G Ray Haversat	6-1	31.4
Mens H Bob Marrotte	7-1	27.6
Mens I Ryan Phipps	7-0	27.8
Elder's Championship		
Jim Pagliarulo	7-0	79.3
Women's Championship		
Deb Scully	7-0	56.9
Cathy Hansen	6-1	60.6
Janet Anzalone	5-2	47.9
Diane Pagano	4-3	40.8
Roxanne Main	3-4	29.6
Carol Atwood	2-5	25.5
Junior Boy's Championship		
Chris Priglia	4-3	20.0
Junior Girl's Championship		
Amy Henson	6-0	37.3

DELAWARE

September 2, 2001		
Class A	W-L	%
Bill Hatton	4-1	48.84
Dan Carter	3-2	48.12
Harold Harget	0-4	43.27
Class B J.R. Bradley	4-2	37.03
Class C Wayne Saulsbury	4-0	30.21
Class D Keith Hudson	4-0	14.50

FLORIDA

Palm Bay April 21, 2001		
Mens Championship	W-L	%
Ron Deckard	11-0	55.45
Glenn Rains	8-3	53.27
Bill Maples	7-4	52.18
Glen E Hoppes	7-4	52.91
Robert Zumbahlen	7-4	51.09
Byron S Jarrett	6-5	44.91
David P Jagers	6-5	48.91
Lionel Gault	4-7	44.91
Oris Miller	3-8	42.00
Ken Duquet	3-8	38.00
Donald Minich	2-9	40.36
Paul A Goss	2-9	41.27
Men B James F Premer	5-1	40.80
Men C F Skip Blum	5-1	38.67
Men D Gino Pepe	4-2	40.33
Men E Robert Moulin	5-1	39.33
Men F Kenneth I Jones	6-0	36.67
Men G Darrell Graham	4-1	30.00
Men H Chris Kitti	5-1	30.33
Men I Herbert Heesch	4-1	26.00
Men J John S Watson	5-1	22.00
Men K Fred Rich	5-0	25.60
Men L Ronald Boltz	6-1	28.33
Men M William Eldridge	4-0	25.00
Men N Donald Lafavers	4-1	17.60
Men O Rick Beverley	4-1	18.80
Elder's Championship		
Gene Straw	7-1	65.94
Wayne Cowger	6-2	63.44
Jerry Huberth	4-3	56.43
William N. Roop	4-3	61.07
James B Adcox	3-4	62.14
Roy Trussell	2-5	62.14
Edwin F Fox	2-5	51.43
W Ray Hood	1-6	53.21
Elder B Michael Tatonetti	7-0	55.00
Elder C Bob McGinty	5-1	33.00
Women's Championship		
Linda Kaercher	6-1	48.29
Dorothy Babe Hood	5-2	54.57
Pam Maples	4-3	50.00
Debbie Burrows	4-3	46.57

Joanne W Simpson	4-3	45.14
Lois Smith	3-4	45.43
Linda Rains	2-5	47.14
Sharon L Long	0-7	24.29
Women B Regina Hawes	5-1	34.67
Women C Maxine Hunt	6-1	32.29
Junior's Championship		
Brady Sunday	7-0	31.67
John Talley	6-1	36.79
Adam Cavanaugh	5-2	10.00
Chad Sunday	3-4	17.14
Lee Seckinger	3-4	12.08
Barbara Coons	3-4	9.58
Donna Coons	1-6	3.33
Jason Martin	0-2	20.00

KANSAS

Men's Championship	W-L	%
Doug McConnell	10-1	55.47
Bernie VanLerberg	8-3	58.02
Les Bartels	8-3	52.44
Bret Vogel	7-4	57.69
Robert Booe	7-4	49.42
Terry Cuthbertson	7-4	48.78
Don Swegel	5-6	51.07
Roger Potts	4-6	45.36
Mike Gerdson	5-7	46.80
Ray Pollard	2-9	44.15
Gary Crumb	2-9	42.29
Tom Routh	1-10	38.53
MEN'S A Ron Martin	10-1	42.86
MEN'S B Ken Martin	10-1	27.89
MEN'S C Jerry Haukap	9-2	35.25
MEN'S D Dan Langley	8-3	16.82
MEN'S E Terry Chaput	9-0	19.69
Elder's Championship		
Merlin Potts	5-0	70.00
Bill Whitley	4-1	66.52
Duane Pollard	2-3	60.73
Richard Potter	2-3	52.78
Harold Hall	1-4	51.67
Alan Hillman	1-4	54.41
Elder's A Marvin Reheis	5-0	41.94
Elder's B Don Mellor	5-0	38.46
Elder's C Glen Smith	6-0	32.50
Elder's D Gene McGraw	5-1	26.14
Women's Championship		
Mary Ann Peninger	5-0	77.81
Deanie Reheis	4-1	52.97
Ora Lee Jeardoe	2-3	46.88
Janelle Peninger	2-3	47.37
Jan VanLerberg	2-3	36.32
Sherry Brusie	0-5	29.89
Wm A Mary Trollope	6-0	32.27
Wm B Claudia Ellerman	6-1	12.92
Junior Boys Championship		
Travis Thompson	6-0	40.36
Joshua Routh	4-2	32.76
Dustin Orr	2-4	21.95
Jr Boys A Travis Turner	6-0	13.75
Junior Girls Championship		
Jamie Edgington	6-0	14.19
Rachel O'Bryan	4-2	8.98
Crystal Bell	2-4	4.48

MANITOBA

July 21, 2001

Men's Class A	W-L	%
Philip Ironstand	9-0	49.73
Wilbert Beaulieu	6-3	46.84
Robert Gosselin	6-3	41.92
William Levasseur	6-3	37.02
Ivan Fisher	6-3	34.51
Shane Smith	4-5	35.53
Levis Malo	3-6	34.76
Don Smith	2-7	31.00
Henry Lecuyer	2-7	28.27
Andre Bernier	1-8	29.18
Men B Larry Connolly	7-1	31.33
Men C Ricky Roulette	8-0	22.44
Senior Men 30 Feet Class A		

Dave Chopek	4-1	29.54
George Crate	1-4	21.21
Senior Men 40 Feet Class A		
Mike Stephans	4-1	40.07
Elmer McMahon	1-4	31.67
Women Class A		
Shirley Ann Fisher	5-1	45.89
Mary Ellen Levasseur	4-2	47.60
Ivy Bullock	0-6	26.92
Women B Sharon Cloud	6-1	33.23
Women C Kay Spikaluk	6-0	6.96

Senior Ladies Class A		
Violet Elliott	4-1	55.00
Elsie Cooke	1-4	28.63

MARITIME PROVINCES

Nova Scotia, New Brunswick and Prince Edward Island.
September 2, 2001

Men Class A	W-L	%
Duncan McKenzie N.S.	7-1	59.00
Barry Slaunwhite N.S.	6-2	51.94
Bernie Devine N.B.	6-2	49.68
Oscar Mongrain N.B.	5-3	35.29
Ray Hebert N.B.	4-4	43.43
Terry Rhindress Sr N.S.	4-4	36.60
Travis Mowatt N.B.	2-6	37.89
Jerry Marr N.S.	2-6	34.22
Darryl Hansen N.B.	0-8	36.12
Men B		
Weldon Richardson Jr. N.B.	7-1	44.02
Men C		
Nou Nou Maltais N.B.	6-1	33.45
Men D Paul Cormier N.B.	7-2	31.66
Men E Rick Lissou N.B.	8-0	39.52
Andy Richardson N.B.	6-1	33.21
Men G Gerry Leblanc N.B.	7-1	27.84
Men H Bill Casey N.B.	6-2	20.00
Men I Jeff Payne N.B.	7-0	31.81
Men J Jim Nicholes PEI	6-1	16.42
Senior Men Class A		
Victor Mosher N.S.	9-2	46.80
Roger Mosher N.S.	9-3	41.42
Walter Muise N.B.	8-3	30.04
Art Drisdale N.S.	4-6	19.12
Clark Brown N.S.	2-8	10.45
Cecil Colwell N.B.	0-10	4.70
Women Class A		
Maxine Crawford N.B.	6-0	30.93
Mary Hansen N.B.	3-3	21.66
Darlene Rathburn N.B.	0-6	17.37
Junior Boys Class A		
Mark Harrison N.S.	8-0	40.90
Adam Hanlin N.B.	4-4	25.62
Johnathan Gray N.B.	4-4	18.58
Jason Brennan N.B.	3-5	13.66
Catlin Richardson N.B.	1-7	13.63

MICHIGAN

September 1-3, 2001

Men's Championship	W-L	%
Tom Williams	9-1	61.36
Douglas Bailey	7-3	60.47
Larry Kemp	7-3	55.53
Marty Quillen	4-6	47.98
Andy Matthews	2-8	51.35
Rod Tanner	1-9	46.65
Men B Claude Gillin	9-2	45.60
Men C Gordon Rogers	10-1	41.99
Men D George Tanner	10-2	37.92
Men E John Arnold	8-1	34.15
Men F Odis Ramsey	9-0	30.31
Men G Charles Bondy	8-2	20.35
Elder's Champion		
Jim Wiltse	0-0	68.69
Elder B Jerry Shene	6-2	52.08
Elder C Bob Warner	11-3	44.53
Women's Championship		
Judy Curtiss	3-1	75.30
Kathy Yaworski	1-3	68.09
Women B Judy Dennis	4-0	55.84

Women C Dee Vela	9-3	34.62
Women D Jennie Petroff	10-2	19.66
Junior Boy's Champion		
Ryan Rademacher	5-0	41.80
Junior Girl's Champion		
Laura Knop	3-2	10.27
Junior B Chris Alderman	4/1	26.58

MINNESOTA

Forest Lake

August 31-September 3, 2001

Men's Championship	W-L	%
Dale Lipovsky	6-1	72.70
Jerry LaBrosse	5-2	61.35
Wayne Totten	5-2	59.89
Mark Baumann	3-4	60.00
Gerald Stangland	3-4	58.85
Dave Hughes	3-4	56.90
Bill Larson	2-5	53.65
Tim Bayerl	1-6	46.85
Men B Dick Moen	6-1	62.74
Men C Myron VanderWeyst	6-1	59.56
Men D Charles Wells	7-0	52.00
Men E Roger Tripp	6-1	43.14
Men F David Haugen	6-1	39.42
Men G Pete Heltunen	6-1	42.57
Men H Jeff Whaatja	7-0	35.14
Men I Earl Tiegs	6-1	35.42
Men J		
Toby Neuenschwander	5-2	34.57
Men K Tracey Seppelt	6-1	32.28
Men L Brian Wipper	6.5-5	44.28
Men M Tom Strandquist	7-0	31.42
Men N Gene Booker	7-0	24.28
Men O John Stanford	6-1	24.00
Men P Andy Broughton	5-2	28.57
Men Q Marvin Timm	5-2	24.57
Men R David Mead	5.5-1.5	17.71
Men S Doug Bollman	5-2	14.28
Senior Men's Championship		
Bert Logsdon	5-1	50.66
Art Moran	4-2	46.42
Bill Grillo	2-4	37.89
Martin Birkholz	1-5	34.61
Senior Men B Les Holland	6-1	33.42
Elder's Championship		
Marvin Meyer	5-1	70.00
Len Lipovsky	3-3	66.66
Lloyd Wolf	3-3	66.66
Harold Schrader	1-5	62.02
Elder B Rusty Henrikson	4-1	62.00
Elder C Richard Olson	5-0	55.20
Elder D Herman Hovda	5-0	34.80
Women's Championship		
Bev Nathe	5-0	68.62
Jan Turnquist	4-1	75.44
Rosie Leyk	2-3	56.34
Edi Holland	2-3	55.95
Pat Stumpf	1-4	63.82
Christy Weyer	1-4	60.91
Wm B Mary Matuke	4-1	57.25
Wm C Paula Mead	6-1	38.28
Wm D Linda Froehlich	7-0	38.00
Wm E Patricia Oakes	4-1	19.20
Junior Boy's Championship		
Lance Albrecht	5-1	67.35
Corey Hughes	4-2	53.41
Patrick Hovda	3-3	53.87
Adam Mead	0-6	21.57
Boy B Jared Froehlich	4-1	45.60
Boy C Aaron Mead	5-0	38.00
Boy D Brian Sheehan	5-0	15.60
Junior Girl's Championship		
Kayla Larson	5-0	39.52
Lana Carlson	3-2	40.67
Ashley Anderson	3-2	37.40
Angie Karow	2-3	30.45
Colette Cave	2-3	24.59
Sarah Nelson	0-5	18.14
Girl B Candace Betterman	6-1	14.00

MISSOURI

St. Joseph September 1-3, 2001		
Men's Championship	W-L	%
Randall Grady	10-1	63.2
M.O. Turner	8-3	64.0
Stan Griggs	7-4	65.8
Kevin Schlimme	7-4	59.2
Charles Killgore	7-4	58.6
Richard Altis	6-5	61.2
Elwyn Cooper	6-5	58.2
Steve Johnson	5-6	59.8
Ron Hassler	4-7	59.2
Dale Parrott	4-7	57.7
Sam Carter	2-9	57.5
Men A Mick Gillette	6-1	56.3
Men B Dan Hobbs	6-1	46.3
Men C Andrew Reeves	7-0	49.1
Men D Daniel Gladden	6-1	43.8
Men E		
Jimmy Higginbotham	6-1	42.1
Men F Kelly Kasper	6-1	37.5
Men G Leonard Lentz	6-2	33.0
Men H Jon McKnight	7-1	36.5
Men I Gary L. Mann	6-2	27.5
Men J Lyle Samuelson	6-1	27.0
Men K Steve Boswell	6-1	30.8
Men L Gregg Craven	7-1	26.8
Men M Cliff Blevins	7-0	24.1
Men N Michael Gillespie	7-2	24.0
Men O Donald Ell	5-1	11.9
Men P Paul Cowherd	5-0	13.2
Men Q Frank McKay	5-0	13.8
Senior's Championship		
Clifford Collins, Sr.	6-1	38.3
Wayne Henderson	4-2	38.3
Paul Taylor	4-2	32.5
Larry Langewisch	2-3	37.2
Douglas Peoples	1-4	28.8
Reese Warden	0-5	25.0
Senior A Don Claas	5-1	28.2
Elder's 30' Championship		
Don Harris	5-0	70.1
Oden Sullivan	4-1	71.9
Don Enke	3-2	64.1
Carlyle Gricks, Jr.	2-3	53.5
George Weldon	1-4	54.9
William Lou Rector	0-5	44.4
Elder A Val Eikel	7-0	36.7
Elder B Leroy Dominique	5-0	45.4
Elder C Gilbert Cox	4-1	29.2
Women's Championship		
Jan Kreienkamp	6-2	61.1
Carolyn Webb	5-3	58.6
Loree Meier	4-3	62.0
Rose Diekamp	4-3	59.8
Pam Henderson	4-3	58.4
Mary Ann Ell	4-3	53.0
Mary Beeson	2-5	45.7
Wm A Audra Craven	6-2	51.8
Wm B Jill Knobbe	6-2	34.8
Wm C Gidget Rahe	6-1	36.9
Wm D Joan Weber	7-0	41.1
Wm E Denise Bloss	5-1	24.3
Wm F Ginny Weiss	5-0	30.9
Junior's Championship		
Tyler Elfrink	5-0	67.6
Mason Jennings	4-1	57.3
Dylan Elfrink	3-2	41.1
Casey Kitchen	2-3	18.9
James M. Gericke	1-4	23.2
Gavin Hughes	0-5	18.7
Junior A Cory Bishop	5-0	24.0

MONTANA

Great Falls August 11 & 12, 2001		
Men's Championship	W-L	%
John Germann	14-1	49.68
Albert Dige	12-3	44.71
Dave Rothwiler	11-4	40.08
John Jolmson	10-5	37.53

Continued next page

STATE TOURNAMENT RESULTS *Continued from page 27*

Malt Urick	10-5	35.42
Rudy Crawford	10-5	34.69
Archie Dulancy	9-6	33.28
Benny Burdahl	8-7	32.94
Dave Wallenwien	7-8	33.68
Steve Steichchen	7-8	31.28
Arnie Mossness	7-8	26.94
Jack Price	6-9	33.37
Nat Clark	4-11	29.24
Ray Kallis	4-11	25.62
GaryRoe	3-12	26.79
Phil Townsend	1-14	27.19
Men's B Doug Holbert	9-3	27.21
Men's C Kelsey Klundt	10-2	30.16
Men's D Shawn Stoltenberg	7-5	21.33
Men's E Dan Klirna	10-2	18.19
Men's F Darin Gullings	10-2	15.31
Senior Men's Championship		
Lindy Ness	14-2	19.49
Women's Championship		
Shelbi Gullings		33.33
Jr. Girl's Championship		
Brandy Juell		3.15
Jr. Boy's Championship		
Andy Juell		32.56

NEBRASKA

North Platte September 1 & 2, 2001		
Men's Championship	W-L	%
Dale Seybert	10-1	62.56
Loren Mills	9-2	53.58
Kelly Petersen	9-2	50.19
Elmer Vogt	7-4	46.10
Terry Hiatt	6-5	46.69
Marcus Thomsen	5-6	47.53
Don Branting	4-7	44.59
Emery Brandt	4-7	43.17
Fay Kapke	4-7	38.00
Ken Jankovitz	3-8	45.14
Rich Switzer	3-8	44.94
Mike Thomsen	3-8	39.51
Men's AA Harvey Schake	7-0	42.51
Men's A Roger Coleman	6-1	45.50
Men's BB Dennis Roggasch	6-1	39.05
Men's B Bob Thomsen	6-1	36.50
Men's CC Richard Kuehn	7-2	24.83
Men's C Robert Hopkins	7-0	31.38
Men's DD Vern Jamison	6-1	15.14
Men's D Steve Fitto	9-0	10.70
Elders Championship		
Gordon Fuhr	4-1	58.70
Bill Nelson	3-2	51.91
Harold Peterson	3-2	50.08
Dick Hanshew	2-3	47.45
Gael Sears	2-3	47.22
Harlan Jensen	0-5	37.90
Elders A Rolly Johnson	7-1	42.55
Elders B Norm Holmberg	5-1	25.16
Women's Championship		
Marion Thomsen	5-0	60.00
Lorraine Gerdes	3-2	51.40
Teri Hanson	3-2	42.50
Velma Smith	2-3	49.60
Bev Hinrichs	2-3	38.68
Sally Grooms	0-5	43.10
Wm A Eunice Lease	5-0	34.50
Wm B Deb Bargstadt	6-1	27.37
Boy's Championship		
Joseph Thomsen	4-1	27.54
Tim Roggasch	4-2	25.95
Casey Painter	2-2	23.03
Boy's A Brett Alswager	3-3	11.06
Girls Championship		
Sara Angel	2-2	21.93
Erin Painter	0-4	10.58
Girls A Heather Drozd	4-2	19.17

NEW BRUNSWICK

August 5, 2001			
Men Class A	W-L	%	
Ray Hebert	6-1	55.92	
Bernie Devine	5-2	47.50	
Gilbert Roussel	5-2	35.29	
Weldon Richardson	3-4	39.28	
Oscar Mongrain	3-4	38.68	
Leo-Paul Gautreau	3-4	35.86	
Darryl Hansen	2-5	38.68	
Claude Leblanc	1-6	25.18	
Men B Stephen Mcfarlane	6-1	41.48	
Men C Darrell Jardine	7-1	38.46	
Men D Mark Perry	7-0	38.57	
Men E David Mclong	7-2	28.88	
Men F Claudius Bourgeois	5-1	35.00	
Men G Nelson Pellerin	7-0	30.35	
Women Class A			
Maxine Crawford	5-1	29.66	
Mary Hansen	4-2	30.00	
Monique Arsenaault	0-6	16.81	

NEW JERSEY

August 5, 2001			
Men's Championship	W-L	%	
Joe McCrink	6/0	74.34	
Hobart Shelton	4/2	61.10	
Rich Fisch	4/2	58.92	
Bob Brown	2/1	59.52	
John Forti	2/4	57.59	
George Patrick	2/4	60.41	
Al Birchler	1/5	55.50	
Men's A Matt Hardy	7/0	50.34	
Men's B Neal Pronek	7/0	52.13	
Men's C Howard Ramer	6/1	26.87	
Men's D Kevin Wolfenden	5/1	26.66	
Men's E Renny Dilks	5/0	16.49	
Men's F Josh Trainor	6/0	22.46	
Class A 30'			
Ed Quigley	6/0	62.35	
30' Class B Jim Marietta	5/0	21.50	
30' Class C Chet Smolenski	4/1	9.15	
Junior Class A			
Justin MacIntyre	6/0	17.50	

NORTH CAROLINA

Statesville September 8, 2001			
Mens Championship	W-L	%	
N.A. Moore	5-0	68.20	
Tommy Gann	4-1	69.00	
Rick Bolick Sr.	3-2	66.10	
Paul Stewart	2-3	60.70	
Dufaye Pearson	1-4	49.00	
Randy Joines	0-5	50.00	
Class A Roy Warren	6-2	48.20	
Class B Jimmy Andrews	6-0	45.00	
Class C Danny Randolph	6-0	41.70	
Class D Ronnie Willis	6-1	26.80	
Class E Oscar Overcash Sr.	5-0	25.00	
Class F Shawn York	5-1	18.80	
Elders Championship			
Tom Eaton	6-1	61.20	
John Patzsch	4-1	63.10	
Earl Caudill	4-3	57.80	
Joe Young	2-3	55.10	
Gil Vallincourt	1-4	37.00	
Womens Championship			
Rivers Prewette	3-0	54.70	
Sheila Bolick	0-3	42.20	
Junior Boys Championship			
Eric Gann	5-0	56.10	

NORTH DAKOTA

Bismarck September 1 & 2, 2001			
Mens Championship	W-L	%	
Jerry Black	7/1	63.02	
Len Hofmann	6/2	51.00	
Gene Lykken	5/2	47.49	

Men's B Gary Erickson	5/2	42.86
Men's C Larry Beardsley	6/1	39.43
Men's D Sam Mitzel	5/2	34.46
Men's E Wyatt Bearsheart	6/1	31.71
Men's F Wade Bachmeier	6/1	28.00
Men's G Lyle Anderson	7/0	16.67
Elder Championship		
Norman Potter	5/1	49.33
Marc Schneider	4/2	51.00
Oral Elhard	3/2	54.40
Elder's B Marvin Tarnasky	5/0	37.20
Elder's C Irwin Wiegier	6/0	23.00
Women's Championship		
Connie Filley	5/1	64.89
Nancy Husted	4/2	45.39
Carol Peterson	3/2	55.00
Wm B Lois Transrud	5/2	32.00
Wm C Wendy Helbling	5/0	22.80
Junior Championship		
Shawn Lunde	5/0	53.78
Jordan Carr	4/1	42.54
Justin Sipma	3/2	39.64
Junior's B Trevor Sipma	5/0	33.60

NOVA SCOTIA

August 18, 2001			
Men Class A	W-L	%	
Duncan McKenzie	7-0	57.95	
Barry Slaunwhite	6-1	55.18	
Larry Harrison	5-2	42.91	
Steve Ziegler	3-4	40.71	
Gary Ross	3-4	40.28	
Chris Cooper	2-5	30.14	
Jerry Marr	1-6	34.44	
Hugie McKenzie	1-6	32.42	
Men B Harold Tatton	5-1	41.11	
Men C Murray Mcleod	6-0	29.44	
Men D Jim Alyward	5-1	29.44	
Men E Art Drisdelle	6-2	16.67	
Senior Men Class A			
Victor Mosher	8-2	43.33	
Roger Mosher	8-2	37.64	
Gus O'quinn	7-3	39.42	
Teddy Gouthro	4-6	32.78	
Jack Whiting	2-8	29.62	
Wilfred Edwards	1-9	21.08	
Women Class A			
Michele Mitchell	7-1	25.18	
Helen George	6-2	21.53	
Judy Bond	4-4	18.24	
Sylvia Mitchell	3-5	20.06	
Dolly George	0-8	9.13	
Junior Boys Class A			
Mark Harrison	9-0	37.00	
Stephen Morse	4-5	15.64	
Andrew Mitchell	3-6	12.04	
Evan Ziegler	2-7	12.68	

OHIO

August 31-September 3, 2001			
Men's Class A	W-L	%	
Jim Walters	11-0	83.38	
Alan Francis	9-2	85.15	
John Walters	8-3	68.18	
Doug Crawford	7-4	69.54	
Bob Lautenschleger	6-5	65.49	
Gary Roberts	6-5	65.34	
Rex Uhrig	5-6	65.92	
John Brown	4-7	65.81	
Loren Coy	4-7	60.69	
Jim Riley	3-8	61.75	
John Singleton	3-8	61.57	
Virgil Rife	0-11	59.62	
Mens B John Knapp Sr.	9-2	59.62	
Mens C Roy Hunt	9-2	56.23	
Mens D Michael Kalb	11-0	56.43	
Mens E Tom King	9-2	47.68	
Mens F Dave Johnson Sr.	10-1	45.21	

Mens G			
Harvey Strausbaugh	7-0	47.60	
Mens H Mike Worthington	6-1	38.00	
Mens I Clarence Dalton	6-1	37.17	
Mens J Steve Powers	6-1	39.75	
Mens K Dave Zuchowski	7-0	34.78	
Mens L Steve Mikesell	7-0	34.78	
Mens M			
Leonard Mike Coyle	6-1	28.90	
Mens N Charlie Jones	6-1	31.44	
Mens O Todd Allen	7-0	35.17	
Mens P Fred Sanford	6-0	27.17	
Mens Q Jeff Prater	4-1	28.69	
Mens R Robert Schweigert	5-1	16.00	
Elder Men's 30' Class A			
Bill Treisch	6-1	63.80	
Earl Vansant	5-2	62.65	
James Coakley	5-2	60.61	
Jim Smith	5-2	57.73	
Elder B Jim Hill	4-3	53.82	
Elder C Zack Campbell	4-1	60.40	
Elder D Robert Sheldon	4.5-1.5	33.21	
Women's Class A			
Amy Francis	7-0	81.03	
Ruth Rife	6-1	63.42	
Donna Dodson	5-2	60.58	
Lisa Conley	4-3	53.13	
Corrine Hibbard	3-4	51.44	
Stacy Sanders	2-5	48.46	
Linda Gheen	1-6	43.21	
Melissa Schindel	0-7	46.98	
Wm B Jan Melick	5-1	55.41	
Wm C Helen Eakins	4-1	35.42	
Wm D Annie Bucy	5-1	19.00	
Junior Boys Class A			
Josh Brooks	6-0	69.80	
Cole Grimm	3-3	48.89	
Jr Boys B A.J. Knapp	3-3	45.52	
Jr Boys C Adam Garver	3-1	23.68	
Junior Girls Class A			
Rebecca Moore	6-0	21.17	
Cassie Thomas	4-2	20.43	
Jr Girls B Rebecca Sellers	2-4	10.29	

OKLAHOMA

Ardmore September 15, 2001			
Men's Championship	W-L	%	
Tom Goff	7-0	60.8	
Charles Cooper	6-1	52.6	
Glenn King	4-3	53.2	
Phillip Morris	4-3	51.2	
Gary Wood	3-4	48.9	
Jerry Holt	2-5	45.0	
Louis Mouse	2-5	42.0	
Harold Gaston	0-7	38.4	
Men's A Harold Gaston	4.5-0.5	43.5	
Men's B Kenneth Priddy	5-0	36.5	
Men's C Homer Cain	6-1	28.9	
Men's D Robert Bryner	6-1	20.7	
Elder's Championship			
Tom Cook	5-1	47.9	
Willard Brakhage	4-2	50.0	
Clyde Matthews	3-2	43.0	
David Beldon	2-3	30.5	
Leonard Burke	1-4	36.0	
Don Blair	1-4	29.5	
Elder's A Bob Reese	6-1	33.1	
Women's Championship			
Wanda Morris	5-0	59.6	
Lucinda Frisbe	4-1	55.6	
Rebecca King	3-2	52.2	
Tina Hawkins	2-3	51.2	
Barbara Goff	1-4	44.0	
Debbie Harris	0-5	44.7	
Wm A Ardith King	4-1	30.5	
Wm B Sandra Leaden	3-0	11.9	
Jr. Boy's Championship			
Ryan Fordyce	1-0	1.0	

Jr. Girl's Championship		
Trina Burk	3-0	16.7
Anita Factor	2-1	10.8
Rebecca Hankins	1-2	0.8
Cori Cook	0-3	0.0

ONTARIO

Woodstock Family Moose Centre September 1-2, 2001

Mens Open Class A	W-L	%
Stanley Leis	10-1	64.94
Adam Ellis	9-2	65.62
Ronald Parisien	9-2	64.36
Kevin Mc Lachlin	7-4	57.55
Steve Hohl	7-4	57.19
Brad Shinn	6-5	54.34
Tom Gallina	5-6	57.40
Tom Stroh	5-6	50.36
Kenneth Drury	3-8	47.87
Hank Rodgers	2-9	50.54
Clyde Smoke	2-9	42.65
Larry Markle	1-10	42.34
Mens B Lloyd Fountain	8-0	55.07
Mens C Edward Bradley	7-1	40.27
Mens D John Taylor	7-2	34.01
Mens E Bob Crawford	7-0	29.71
Mens F James Wilce	6-2	35.00
Mens G Wally Arnold	6-1	30.79
Mens H Bud Davis	5-2	27.69
Mens I Peter Couture	7-1	26.89
Mens J Alfred Trudel	5-0	18.50
Mens K Terry Musgrave	5-0	15.50
Senior Men 30 Feet Class A		
Edwin Danby	8-0	50.78
Don Borody	5-3	45.74
Benny McDonald	3-5	35.15
Buster Duck	2-6	37.17
Alister Springall	2-6	36.50
Women Open Class A		
Sandra Janssens	7-0	73.38
Lucille Leis	6-1	65.43
Kim Gohl	4-3	52.84
Denise Stanley	4-3	51.60
Sheila Mc Grath	4-3	50.63
Laura Nahls	2-5	40.25
Carol Kurt	1-6	39.93
Tamara Becker	0-7	39.32
Wm B Chris Karn	5-1	37.10
Wm C Tina Johnson	6-0	34.40
Wm D Pat Martin	5-1	17.91
Juniors Class A		
Drew Becker	6-0	67.50
Kelly Mallette	2-4	47.41
Brian Mc Lachlin	1-5	42.79
Jr B Alex Vienneau	7-1	38.21
Jr C Jessica Deline	6-1	17.61

QUEBEC

Victoriaville September 1-2, 2001

Mens Class A	W-L	%
Gilles Mc Carthy	15-3	59.84
Lionel Laroche	12-5	54.27
Sylvain Demers	12-4	54.21
Louis Prud'homme	11-4	57.61
Reginald Lavoie	10-5	58.35
Jean Paul Noury	10-5	53.64
Gaetan Dallaire	9-6	53.88
Denis Paradis	8-7	52.76
Jacquelin Menard	7-8	47.31
Roger Lussier	6-9	54.37
Rosaire Brunelle	5-10	48.84
Jean-Marie Laliberte	5-10	48.24
J.-Neil Chateauvert	5-10	45.20
Jean-Pierre Renaud	4-11	50.27
Bruno Cote	2-13	42.21
Rene Croteau	2-13	46.73
Mens B Martin Provencher	8-2	53.13
Mens C Marcel Giguere	8-1	52.46
Mens D Maurice Malouin	9-0	49.27
Mens E Yvan Sylvestre	6-2	44.87
Mens F Romuald Richard	8-1	31.20

Mens G Mario Lacasse	8-0	24.01
Mens H Claude Roy	7-0	23.19
Senior 30' Class A		
Ovila Ouellet	5-0	55.11
Lucien Hamel	4-1	56.02
Rolland Desrocher	2-3	47.96
Jean-Paul H. Cote	2-3	42.55
Marcel Guilbeault	2-3	40.74
Raymond Salvais	0-5	32.69

Ladies Class A	W-L	%
Claudette Moreau	9-3	59.14
Lucy Thibault	8-2	70.78
Lise Dufault	5-3	63.14
Denise Bibeau	5-2	58.02
Carole Carrier	3-4	56.00
Diane Chaunt	2-5	50.26
Lise Tardif	1-6	50.92
Melanie Cote	0-7	40.22
Ladies B Lyne Pineault	6-1	56.25
Ladies C Paulette Gelinias	6-1	37.18
Juniors Class A		
Pascal Martineau	4-1	33.16
Alexandre Bedard	1-4	28.57

SASKATCHEWAN

Manitou Beach June 23, 2001

Mens A	W-L	%
Marvin Ellison	3-1	63.79
Colin Finie	2-2	65.76
Howard Weitzel	1-3	65.13
Mens B Dale Squires	5-2	47.85
Mens C Lorne Elwood	4-1	44.50
Mens D Ron Kalaman	4-0	26.87
Sr Men 30' A		
Mike Spilchen	2-0	63.15
Russell Christopher	0-2	46.05
Sr 30' B Jules Liebaert	5-2	47.34
Sr 30' C Basil Nybo	5-0	41.57
Sr 30' D George Demmans	6-0	18.48
Sr Men 40' A		
Vern Tyacke	3-1	54.20
Al Ross	2-2	47.14
George Wingham	1-3	46.61
Sr Men 40' B		
Lewis Warkentin	3-0	31.66
Womens A		
Tammy Norvila	4-1	54.73
Pauline Spilchen	3-2	58.67
Eileen Kozakewich	0-4	47.47
Wm B Sharon Clark	5-2	33.81
Wm C Margaret Kemp	5-0	33.15
Junior Boys Class A		
Shane Dubyk	5-1	20.78
Dean Dale Squires	3-3	11.66
Junior Girls A		
Kristie Demmans	4-2	7.30
Jaala Curren	0-6	6.11

SOUTH DAKOTA

September 1, 2001

Mens Class A	W-L	%
LaVerne Wipf	5/1	44.29
Milton Renville	4/2	47.86
Roland Kleinschmidt	3/2	46.00
Carl Chambers	2/3	35.60
Vine Marks	1/4	34.80
Patrick Kanaly	1/4	32.40
Mens B John Smith	5/1	32.67
Mens C Clair Harris	6/1	23.33
Mens D Lovell Wheeler	5/1	10.86
Elder's Class A		
Gwyn Jewett	5/0	28.00
David Zilverberg	4/1	42.00
Clint Bryson	3/2	25.60
Donald Benbrooks	2/3	10.40
Gene Ewing	1/4	16.80
Robert Weimer	0/5	9.60
Ladies Class A		
Iris Sharpfish	4/1	42.17
Phyllis Wheeler	3/2	47.39

Julie Warren	2/2	33.00
Dee Steineke	1/3	16.00
Mickey Lodge	1/3	7.00
Junior's Class A		
Tyler Wipf	5/1	45.00
Kyle Stover	4/2	39.00
John Stover	3/3	31.33
Curtis Williams	0/6	5.33
Junior's B Shaina Stover	6/0	21.00

Men B Julian Caldwell	7-0	57.09
Men C Kevin Keith	7-2	45.70
Men D Bill Jarrell	6-1	41.03
Men E Dudley Thorn	6-1	39.06
Men F Wayne Huggins	6-1	38.75
Men G Paul Kipp	5-2	29.76
Men H Joe Hogsett	7-0	30.07
Men I Mark Huggins	6-1	32.14
Men J Joe Pumphrey	7-0	19.73
Men K Don Jarrett	7-1	15.32

WEST VIRGINIA

Parkersburg September 14, 2001

Men's Championship	W/L	%
JerryWykie	10-1	66.08
Rick Cale	9-2	61.73
Doug Cook	8-3	67.14
Richard Johnson	7-4	64.07
Dave Holmes	7-4	63.18
Mike Stout	6-5	58.70
Cliff Powell	5-6	48.99
Mike Stoner	4-7	58.63
Howard Barnett	3-8	58.04
Allen Withrow	3-8	53.31
Floyd Riggelman	3-8	50.57
Joe Cochran	1-10	49.24
Elder's Championship		
Earl Huggins	6-0	47.98
Ken Wilhelm	4-2	39.67
Roosevelt Gray	2-4	31.12
Women's Championship		
Brenda Tawney	6-1	72.93
Tamara Burke	5-2	65.20
Rosalie Judy	2-4	54.25
Wm B Dorothy Akers	6-1	41.03
Jr. Boy's Championship		
Randall Owens	6-0	31.25
Cliffy Powell	4-2	11.88
Jamie Owens	2-4	6.30
Jr. Girl's Championship		
Heather Powell		35.09

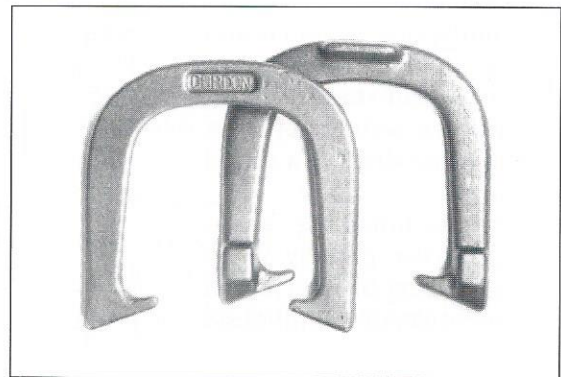

GORDON

HORSESHOES

To purchase shoes

ORDER BY PHONE—TOLL FREE:
888-321-7200



accepted

OR

SEND YOUR CHECK or MONEY ORDER TO:
Gordon Horseshoes
c/o Queen City Forging Co.
233 Tennyson St., Cincinnati, Ohio 45226

OR

e-mail order to: gordon@qcforge.com
Our web site is at <http://www.qcforge.com>

THE TOLL OF TIME

RANDOLPH "BUD" FREEMAN

October 19, 1933–May 26, 2001

It is with extreme sadness that the Frederick Horseshoe Pitchers Association of Maryland reports the passing of Bud Freeman. He was 66 years young. Bud joined the FHPA in 1996. He was dedicated to the sport of horseshoe pitching and acted as a goodwill ambassador in all he did. He loved the game, and it showed in his constant good cheer and enthusiasm. Despite living nearly an hour away from the location of our courts, he was present and active for nearly every event—rain or shine. An active league member, Bud showed his support by recruiting new members and by assisting and participating in "work nights" and tournaments. Rarely was he seen without a pair of horseshoes, a score sheet or a shovel in his hands.

Bud wore his horseshoe log t-shirts, hat and jackets proudly. When not actually pitching or working on the courts, he handcrafted birdhouses to raffle off for club fundraising events. He loved to pitch, pitch, pitch, playing and practicing with club members, including his son, Randy. He also enjoyed dancing and collecting hugs and was always fun to be around.

Horseshoe pitching meant so much to Bud, that he put in a set of pits at his home, and proceeded to construct a building around them. He invited friends over to pitch year-around. He posted a list of everyone who had ever pitched with him in his "shoe shack."

Bud left behind the love of his life, Fran, to whom he was devoted. He is loved and missed by his son, Randy (also a member of our club), daughters Susan and Christy and nine grandchildren.

While the members of the FHPA know that Bud is happily pitching horseshoes in heaven (and likely adding some pretty special people to his "pitched against list"), we will miss him and think of him often. He was like a family member to many of us and a friend to us all.



CHARLES PRINGLE

Charles Pringle of Lawrence, Kansas passed away May 26, 2001 at the age of 78. Charlie began pitching

horseshoes 12 years ago. He was highly competitive in all the sports he pursued. He enjoyed playing golf, pitching horseshoes, playing a game of pool at the local Senior Center and telling stories about his life's adventure. A high point in his life was in 1999 at the World Tournament in Greenville, Ohio. Charlie won first place in his class of the Elder's Divi-

sion pitching a 67.5% average. He competed in three world Tournaments, 1997 through 1999.

Charlie was a retired self-employed paint contractor. He was a member of the VFW Alford-Clarke Post #852 and the Eagles in Lawrence, Kansas. He was an Army veteran of World War II, serving in England, France, Germany and Austria. Charlie is survived by Ruby, his wife of 54 years, two sons, one daughter, nine grandchildren and eight great-grandchildren.

CARL NIELSEN

Carl Nielsen of North Platte, Nebraska passed away May 31, 2001. He was 82 years old and a member of the Platte Valley Pitchers Horseshoe Club since it started in 1987. He will be sadly missed by all of his many friends and relatives.

THE HORSESHOE PITCHER'S COMPANION

FEATURES: Pat. No. 4,399,614

1. Calipers for measuring close points.
2. File to remove burrs from shoes.
3. A 6" notch for measuring legal points.
4. Straight edge for measuring ringers.
5. Scraper for removing dirt, mud, etc.
6. Just the right size for back pockets.
7. NHPA approved.

\$9.95
(2 or more: \$9.00 each)

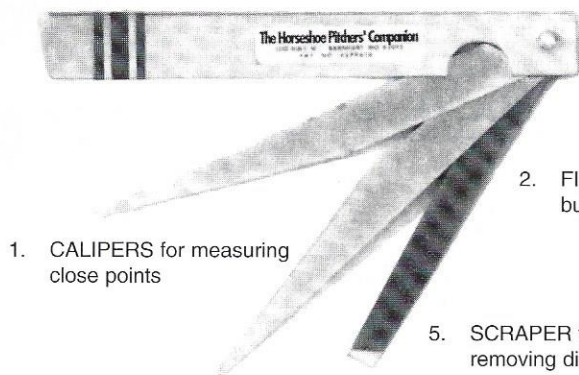

1. CALIPERS for measuring close points

4. STRAIGHT EDGE for measuring ringers

3. 6" NOTCH for legal points

2. FILE to remove burrs from shoes

5. SCRAPER for removing dirt

Send to: Horseshoe Pitcher's Companion
2058 Woods Circle
Barnhart, MO 63012
(Add \$1.50 for postage and handling)



**WE'VE
GOT
WHAT
YOU
NEED!**

NHPA GAME RELATED SALES DISTRIBUTORS

EDWARD A. DOMEY

National Buyer

P.O. Box 298
Sutton, Massachusetts 01590
(508) 865-9477 Phone or Fax

DENNIS OHMS

777 W. Midvalley Road
Cedar City, Utah 84720
(435) 586-9352
ohms@netutah.com

GEORGE ANDERSON

1869 Mourning Dove Drive
Palm Harbor, Florida 34683
(727) 786-1128
juniaf@msn.com

KEN KOSKY

Assistant National Buyer
6007 Municipal Street
Schofield, WI 54476
(800) 535-0172

WALLY SHIPLEY

2646 Basswood Street
Newport Beach, CA 92660
(949) 760-3658

CURLY SEIBOLD

1043 Grayston Avenue
Huntington, Indiana 46750
(800) 356-3489
wseibold@fwi.com

LUCKY SHOES PRO SHOP

83441 CR 652
Lawton, MI 49065
(616) 624-2861
luckshoe@juno.com

ANDY'S Horseshoe Products

1746 Patrick's Bay
Fairbault, MN 55021-5544
(866) 283-5602
abro@LL.net

Support Your National Horseshoe Pitchers Association

Contact a Distributor near you for the products shown in this ad and many other Game Related Items

NHPA NEWSLINE

Subscription Office

3085 76th St., Franksville, WI 53126

CHANGE SERVICE REQUESTED

PRESORTED
STANDARD
US POSTAGE PAID
LANSING, MI
PERMIT NO 933

St. Pierre AMERICAN Tournament... HORSESHOES

THROW RINGERS AROUND THE COMPETITION.

UNIQUE SHAPE FOR CONSISTENT PERFORMANCE

- Longer hooks grab the stake
- Ringer breaker rotates shoe to lock in ringers
- Calks engineered for balance
- Built-in finger positioner
- Exclusive new high-tech powder coat finish
- Manufactured of forged steel

Our shoes are drop forged of solid steel and then given our exclusive smooth, electrostatically applied baked-on powder coating, a finish that's more resistant to chipping, abrasion, corrosion and weathering than ordinary paint. Only St. Pierre offers this durable, attractive finish. Our forged shoes also offer the proper weight distribution for maximum balance and control, and meet the official size and weight requirements of the National Horseshoe Pitchers' Association (NHPA). We forge strength right into the design, too, so St. Pierre shoes last longer than cast products.



NHPA
APPROVED



Made in USA

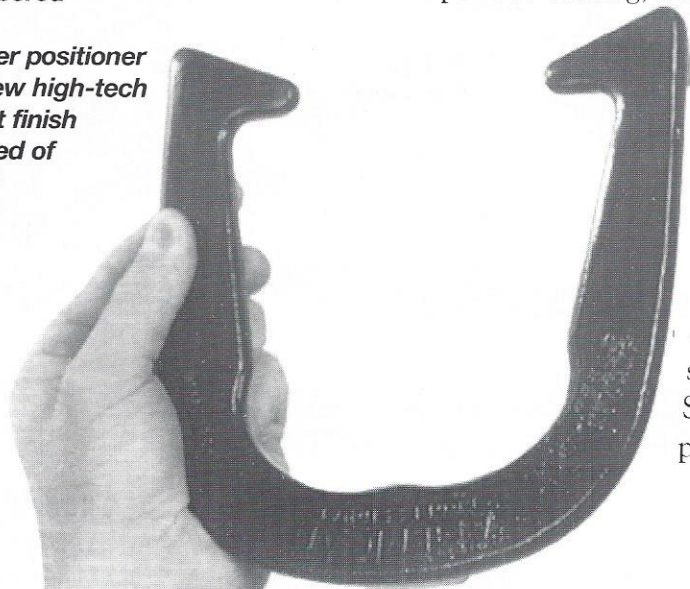

St. Pierre
MANUFACTURING CORPORATION

317 East Mountain Street

Worcester, MA 01606

Tel: (508) 853-8010 Fax: (508) 853-3860